

JVC

**DVD/CD PLAYER
Hi-Fi STEREO
VIDEO CASSETTE
RECORDER
USER'S GUIDE**

VHS SQPB

4 HEAD

19µm HEAD

Hi-Fi

*For model:
HR-XVC1U*

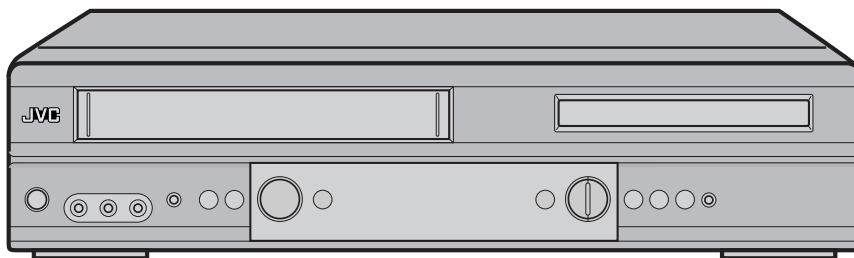



For Customer Use:

Enter below the Model No. and Serial No. which are located on the rear of cabinet.
Retain this information for future reference.

Model No. _____

Serial No. _____

	CAUTION RISK OF ELECTRIC SHOCK DO NOT OPEN	
<p>CAUTION: TO REDUCE THE RISK OF ELECTRIC SHOCK, DO NOT REMOVE COVER (OR BACK). NO USER-SERVICEABLE PARTS INSIDE. REFER SERVICING TO QUALIFIED SERVICE PERSONNEL.</p>		



The lightning flash with arrowhead symbol, within an equilateral triangle is intended to alert the user to the presence of uninsulated dangerous voltage within the product's enclosure that may be of sufficient magnitude to constitute a risk of electric shock to persons.



The exclamation point within an equilateral triangle is intended to alert the user to the presence of important operating and maintenance (servicing) instructions in the literature accompanying the appliance.

<p>WARNING: TO REDUCE THE RISK OF FIRE OR ELECTRIC SHOCK, DO NOT EXPOSE THIS APPLIANCE TO RAIN OR MOISTURE.</p>
<p>CAUTION: TO PREVENT ELECTRIC SHOCK DO NOT USE THIS POLARIZED PLUG WITH AN EXTENSION CORD, RECEPTACLE OR OTHER OUTLET UNLESS THE BLADES CAN BE FULLY INSERTED TO PREVENT BLADE EXPOSURE.</p>

CAUTION: Changes or modifications not expressly approved by the party responsible for compliance with the FCC Rules could void the user's authority to operate this equipment.

<p>CAUTION: THIS DIGITAL VIDEO PLAYER EMPLOYS A LASER SYSTEM.</p>
<p>TO ENSURE PROPER USE OF THIS PRODUCT, PLEASE READ THIS USER'S GUIDE CAREFULLY AND RETAIN FOR FUTURE REFERENCE. SHOULD THE UNIT REQUIRE MAINTENANCE, CONTACT A JVC AUTHORIZED SERVICE CENTER.</p>
<p>USE OF CONTROLS, ADJUSTMENTS OR THE PERFORMANCE OF PROCEDURES OTHER THAN THOSE SPECIFIED HEREIN MAY RESULT IN HAZARDOUS RADIATION EXPOSURE.</p>
<p>TO PREVENT DIRECT EXPOSURE TO LASER BEAM, DO NOT TRY TO OPEN THE ENCLOSURE. VISIBLE LASER RADIATION MAY BE PRESENT WHEN THE ENCLOSURE IS OPENED. DO NOT STARE INTO BEAM.</p>

Location of the required Marking

The rating sheet and the safety caution are on the rear of the unit.

CERTIFICATION: COMPLIES WITH FDA RADIATION PERFORMANCE STANDARDS, 21 CFR SUBCHAPTER J.

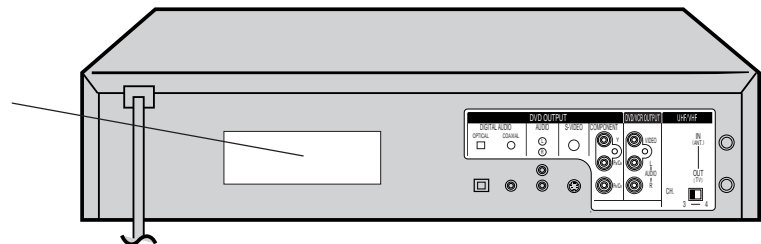

IMPORTANT SAFEGUARDS

1. READ INSTRUCTIONS

All the safety and operating instructions should be read before the unit is operated.

2. RETAIN INSTRUCTIONS

The safety and operating instructions should be retained for future reference.

3. HEED WARNINGS

All warnings on the unit and in the operating instructions should be adhered to.

4. FOLLOW INSTRUCTIONS

All operating and use instructions should be followed.

5. CLEANING

Unplug this unit from the wall outlet before cleaning. Do not use liquid cleaners or aerosol cleaners.

Use a damp cloth for cleaning the exterior cabinet only.

6. ATTACHMENTS

The manufacturer of this unit does not make any recommendations for attachments, as they may cause hazards.

7. WATER AND MOISTURE

Do not use this unit near water. For example, near a bathtub, washbowl, kitchen sink, laundry tub, in a wet basement, or near a swimming pool.

8. ACCESSORIES

Do not place this unit on an unstable cart, stand, tripod, bracket, or table.

The unit may fall, causing serious injury, and serious damage to the unit.

An appliance and cart combination should be moved with care. Quick stops, excessive force, and uneven surfaces may cause the appliance and cart combination to overturn.

9. VENTILATION

Slots and openings in the cabinet back or bottom are provided for ventilation, to ensure reliable operation of the unit, and to protect it from overheating.

These openings must not be blocked or covered. The openings should never be blocked by placing the unit on a bed, sofa, rug, or other similar surface. This unit should never be placed near or over a radiator or heat source. This unit should not be placed in a built-in installation such as a bookcase or rack unless proper ventilation is provided and/or the manufacturer's instructions have been adhered to.

10. POWER SOURCES

This unit should be operated only from the type of power source indicated on the rating plate. If you are not sure of the type of power supply to your home, consult your appliance dealer or local power company. For units intended to operate from battery power, or other sources, refer to the operating instructions.

11. GROUNDING OR POLARIZATION

This unit is equipped with a polarized alternating-current line plug (a plug having one blade wider than the other). This plug will fit into the power outlet only one way. This is a safety feature. If you are unable to insert the plug fully into the outlet, try reversing the plug. If the plug should still fail to fit, contact your electrician to replace your obsolete outlet. Do not defeat the safety purpose of the polarized plug, if your unit is equipped with a 3-wire grounding-type plug, a plug having a third (grounding) pin. This plug will only fit into a grounding-type power outlet. This too, is a safety feature. If you are unable to insert the plug into the outlet, contact your electrician to replace your obsolete outlet. Do not defeat the safety purpose of the grounding-type plug.

12. POWER-CORD PROTECTION

Power-supply cords should be routed so that they are not likely to be walked on or pinched by items placed upon or against them, paying particular attention to cords at plugs, convenience receptacles, and the point where they exit from the appliance.

PORTABLE CART WARNING
(symbol provided by RETAC)



S3125A

IMPORTANT SAFEGUARDS

13. LIGHTNING

To protect your unit from a lightning storm, or when it is left unattended and unused for long periods of time, unplug it from the wall outlet and disconnect the antenna or cable system. This will prevent damage to the unit due to lightning and power line surges.

14. POWER LINES

An outside antenna system should not be located in the vicinity of overhead power lines or other electric light or power circuits, or where it can fall into such power lines or circuits. When installing an outside antenna system, extreme care should be taken to keep from touching such power lines or circuits, as contact with them might be fatal.

15. OVERLOADING

Do not overload wall outlets and extension cords, as this can result in a risk of fire or electric shock.

16. OBJECT AND LIQUID ENTRY

Do not push objects through any openings in this unit, as they may touch dangerous voltage points or short out parts that could result in fire or electric shock. Never spill or spray any type of liquid into the unit.

17. OUTDOOR ANTENNA GROUNDING

If an outside antenna or cable system is connected to the unit, be sure the antenna or cable system is grounded to provide some protection against voltage surges and built-up static charges. Section 810 of the National Electrical Code, ANSI/NFPA 70, provides information with respect to proper grounding of the mast and supporting structure, grounding of the lead-in wire to an antenna discharge unit, size of grounding conductors, location of antenna discharge unit, connection to grounding electrodes, and requirements for the grounding electrode.

18. SERVICING

Do not attempt to service this unit yourself as opening or removing covers may expose you to dangerous voltage or other hazards. Refer all servicing to qualified service personnel.

19. DAMAGE REQUIRING SERVICE

Unplug this unit from the wall outlet and refer servicing to qualified service personnel under the following conditions:

- a. When the power-supply cord or plug is damaged.
- b. If liquid has been spilled, or objects have fallen into the unit.
- c. If the unit has been exposed to rain or water.
- d. If the unit does not operate normally by following the operating instructions. Adjust only those controls that are covered by the operating instructions, as an improper adjustment of other controls may result in damage and will often require extensive work by a qualified technician to restore the unit to its normal operation.
- e. If the unit has been dropped or the cabinet has been damaged.
- f. When the unit exhibits a distinct change in performance, this indicates a need for service.

20. REPLACEMENT PARTS

When replacement parts are required, be sure the service technician uses replacement parts specified by the manufacturer or those that have the same characteristics as the original part.

Unauthorized substitutions may result in fire, electric shock or other hazards.

21. SAFETY CHECK

Upon completion of any service or repairs to this unit, ask the service technician to perform safety checks to determine that the unit is in proper operating condition.

22. HEAT

The product should be situated away from heat sources such as radiators, heat registers, stoves, or other products (including amplifiers) that produce heat.

23. DISC TRAY

Keep your fingers away from the disc tray as it is closing. It may cause serious personal injury.

24. CONNECTING

When you connect the product to other equipment, turn off the power and unplug all of the equipment from the wall outlet. Failure to do so may cause an electric shock and serious personal injury. Read the owner's manual of the other equipment carefully and follow the instructions when making any connections.

IMPORTANT SAFEGUARDS / Power Source

25. LASER BEAM

Do not look into the opening of the disc tray or ventilation opening of the product to see the source of the laser beam. It may cause sight damage.

26. DISC

Do not use a cracked, deformed, or repaired disc. These discs are easily broken and may cause serious personal injury and product malfunction.

27. NOTE TO CATV SYSTEM INSTALLER

This reminder is provided to call the CATV system installer's attention to Article 820-40 of the NEC that provides guidelines for proper grounding and, in particular, specifies that the cable ground shall be connected to the grounding system of the building, as close to the point of cable entry as practical.

EXAMPLE OF ANTENNA GROUNDING AS PER THE NATIONAL ELECTRICAL CODE

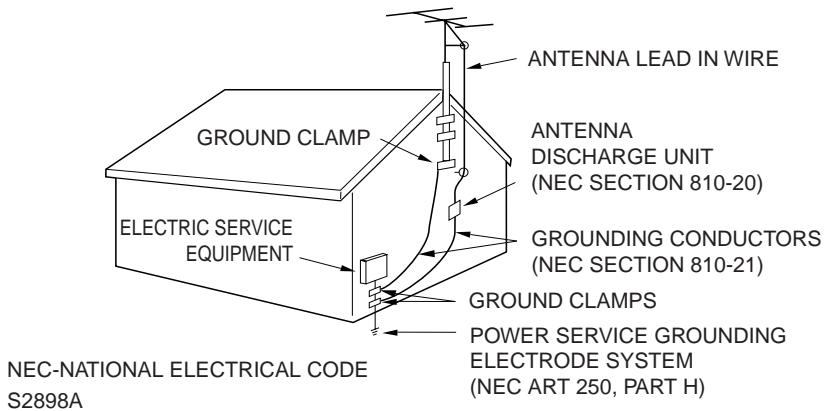

CONDENSATION

Moisture will form in the operating section of the DVD/VCR if the player is brought from cool surroundings into a warm room or if the temperature of the room rises suddenly. And when this happens, DVD/VCR's performance will be impaired.

To prevent this, let the DVD/VCR stand in its new surroundings for about an hour before switching it on, or make sure that the room temperature rises gradually.

Condensation may also form during the summer if the DVD/VCR is exposed to the breeze from an air conditioner. In such cases, change the location of the DVD/VCR.

Power Source

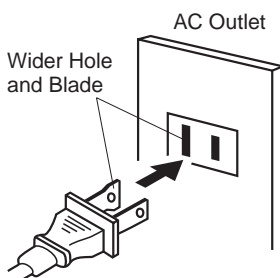

Polarized AC Cord Plug
(One blade is wider than the other.)

TO USE AC POWER SOURCE

Use the AC polarized line cord provided for operation on AC. Insert the AC cord plug into a standard 120V 60Hz polarized AC outlet.

NOTES:

- Never connect the AC line cord plug to other than the specified voltage (120V 60Hz). Use the attached power cord only.
- If the polarized AC cord does not fit into a non-polarized AC outlet, do not attempt to file or cut the blade. It is the user's responsibility to have an electrician replace the obsolete outlet.
- If you cause a static discharge when touching the unit and the unit fails to function, simply unplug the unit from the AC outlet and plug it back in. The unit should return to normal operation.

Features

DVD/CD Player/Video Cassette Recorder

- **DVD/CD player with Video Cassette Recorder** - Unique space saving design combines a DVD/CD player and a Hi-Fi Video cassette recorder. The DVD disc has much more capacity, but is the same size as the audio CD disc. Picture quality is higher than Super VHS. Audio quality is higher than audio CD. The DVD PLAYER can play back video CDs and audio CDs.
- **High Quality Picture** - More than 500 lines(VCR mode: 230 lines) of Horizontal Resolution. It exceeds Super VHS (400 lines) or Laser Disc (430 lines) in resolution.

VCR Section

- **Stereo/SAP Reception** - This VCR is designed to receive stereo and separate audio program (SAP) broadcasts where available.
- **SQPB** - Tapes recorded in the S-VHS system can be played back simply on this VCR.
- **4 Video Heads** - Provides optimal picture quality for special effects playback.
- **19µm HEAD** - For superior picture quality even in EP mode, 19micron width technology helps to avoid crosstalk and boost EP picture quality to near SP levels. With precision technology, ghosts and color beats are virtually eliminated.
- **Hi-Fi Stereo Sound** - With a frequency response of 20 to 20,000 Hz and a dynamic range of better than 90dB, this VCR provides a level of excellence that rivals compact discs.
- **Instant Timer Recording (ITR)** - Simply by pressing the REC and PLAY buttons, the VCR can be programmed for up to 5 hours of recording with an immediate start.
- **Skip Search** - When the SKIP SEARCH button is pressed during playback, the VCR will automatically search forward in 30 seconds increments to a maximum of 3 minutes with each press of the SKIP SEARCH button, and then return to normal playback.

DVD Section

- **Compatible with a wide range of DVD audio outputs**
Digital Audio Jack (Optical or Coaxial):
 - When a component with a built-in Dolby Digital decoder is connected, Dolby Digital sound can produce the effect of being in a movie theater or a concert hall.
 - Surround standard different from Dolby Digital. This format is already in use in many theaters. By connecting this unit to a DTS decoder or an AV amplifier with a built-in DTS decoder, the DTS audio of DVD discs recorded in this format can be enjoyed. However, audio will not be output from the analog audio output jacks.
 - The MPEG audio of DVD discs recorded in this format can be enjoyed.
 - The Linear PCM sound of a 48 kHz/16 bit through 96 kHz/20 bit exceeds audio CD sound.
- **Surround audio** - This DVD equipped with a "SPATIALIZER N-2-2". It can produce the effect of being in a cinema or a concert hall.
- **Multi-Language** - Since this DVD matches with 124 language-subtitles/-soundtracks, you can enjoy selecting a favorite one. (You can not select the language that is not recorded on the disc.)
- **Multi-Angle** - Pictures of Sports or a Live Concert are recorded with many cameras. When you play such a disc, you can change the angles during playback. (If a Multi-Angle is not recorded on the disc, you can not change the angle.)
- **Repeat Playback** - You can repeat chapter, track, title, sides or material between two selected points.
- **Program/Random Playback (CD)** - You can play back tracks in programmed or random-selected sequences.
- **Zoom** - You can zoom in on the selected subject on the screen during playback.
- **Video Aspect Ratio** - You can change the aspect ratio of the screen for your monitor/television on a suitable disc.
- **Parental Control** - You can limit the playback of scenes or sounds of adult DVD discs which have a parental level rating.

* This product incorporates copyright protection technology that is protected by method claims of certain U.S. patents and other intellectual property rights owned by Macrovision Corporation and other rights owners. Use of this copyright protection technology must be authorized by Macrovision Corporation or other rights owners and is intended for home and other limited viewing uses only unless otherwise authorized by Macrovision Corporation or other rights owners. Reverse engineering or disassembly is prohibited.

* Manufactured under license from Dolby Laboratories. "Dolby" and the double-D symbol are trademarks of Dolby Laboratories. Confidential unpublished works. © 1992-1997 Dolby Laboratories, Inc. All rights reserved.

* "DTS" and "DTS Digital Out" are trademarks of Digital Theater Systems, Inc.

* Certain audio features of this product manufactured under license from Desper Products, Inc. Spatializer and the circle - in - square device are trademarks owned by Desper Products, Inc.

* Unauthorized recording of copyrighted television programs, films, video cassettes and other materials may infringe the rights of copyright owners and be contrary to copyright laws.

Before using your unit

Important safeguards	3
Power Source	5
Features	6
Contents	7
Parts and functions	8
Display	9
Remote control	10
Basic connections	12
CATV (CABLE TV) connections	14
Playback Connection	16

Setting up the VCR section

Setting the Video Channel	18
Setting the language	18
Tuner Setting	19
To ADD/DELETE channels	20
Noise elimination	20
Auto clock setting	21
Manual clock setting	23
Loading and Unloading a Cassette Tape	24

Tape Playback operation

Cassette tape Playback	25
Special playback	26
ZERO RETURN function	27
Video Index Search system	27

Recording

Recording a TV program	28
Instant Timer Recording (ITR)	30
Timer Recording	31

Advanced Function of VCR section

Stereo Recording and Playback	33
Separate Audio Program (SAP)	33
Duplicating a video tape	34
Duplicating a disc material onto a video tape	34

Disc Playback operation

Disc	35
Setting setup language	36
Playback procedure	37
Special playback	38
Zooming	39
Locating Desired Scene	39
Repeat playback	40
Program playback (CD)	41
Random playback (CD)	41
MP3 Playback	42
Marking Desired Scenes	43
Changing soundtrack language	44
Subtitles	44
Changing angles	45
Title selection	45
DVD menu	45

Advanced Function of DVD section

Parental control	46
Temporary disabling of rating level by DVD disc	47
Setting menu language	48
Setting subtitle language	49
Setting audio soundtrack language	50
Setting surround sound	50
Setting the aspect ratio of TV screen	51
Setting on Screen display	52
Status display of Disc	52
Dynamic Range Control	53
Language Code List	54

Additional information

Problems and troubleshooting	55
Video head cleaning	56
Specifications	57
HOW TO LOCATE YOUR JVC SERVICE CENTER	58
LIMITED WARRANTY	59

Parts and functions

Front

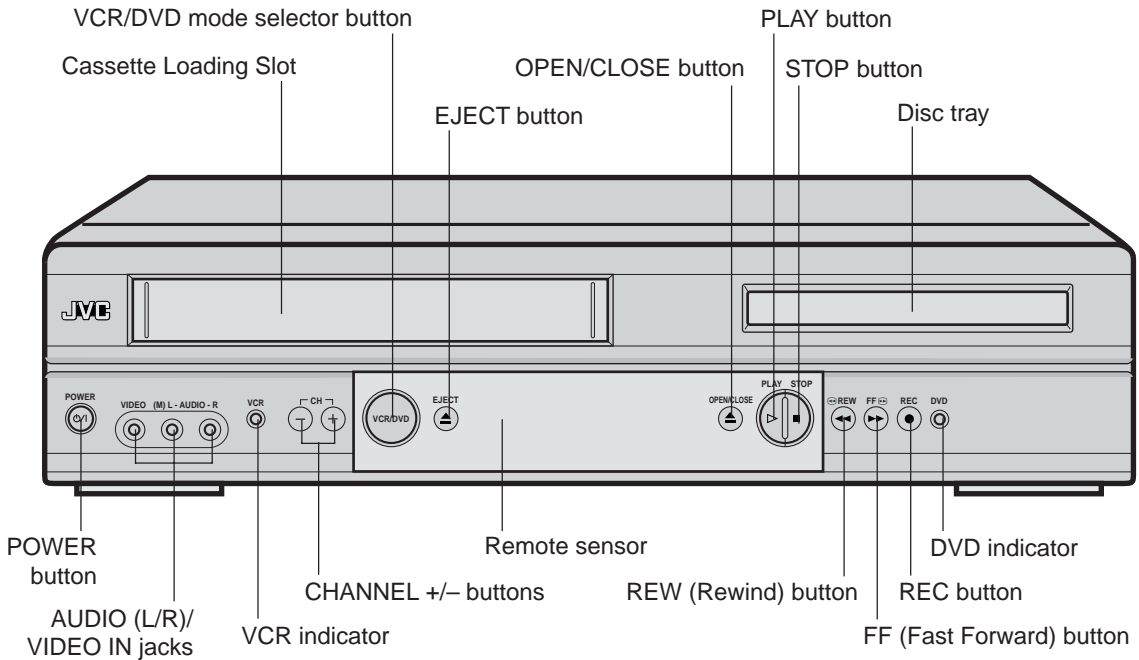

Rear

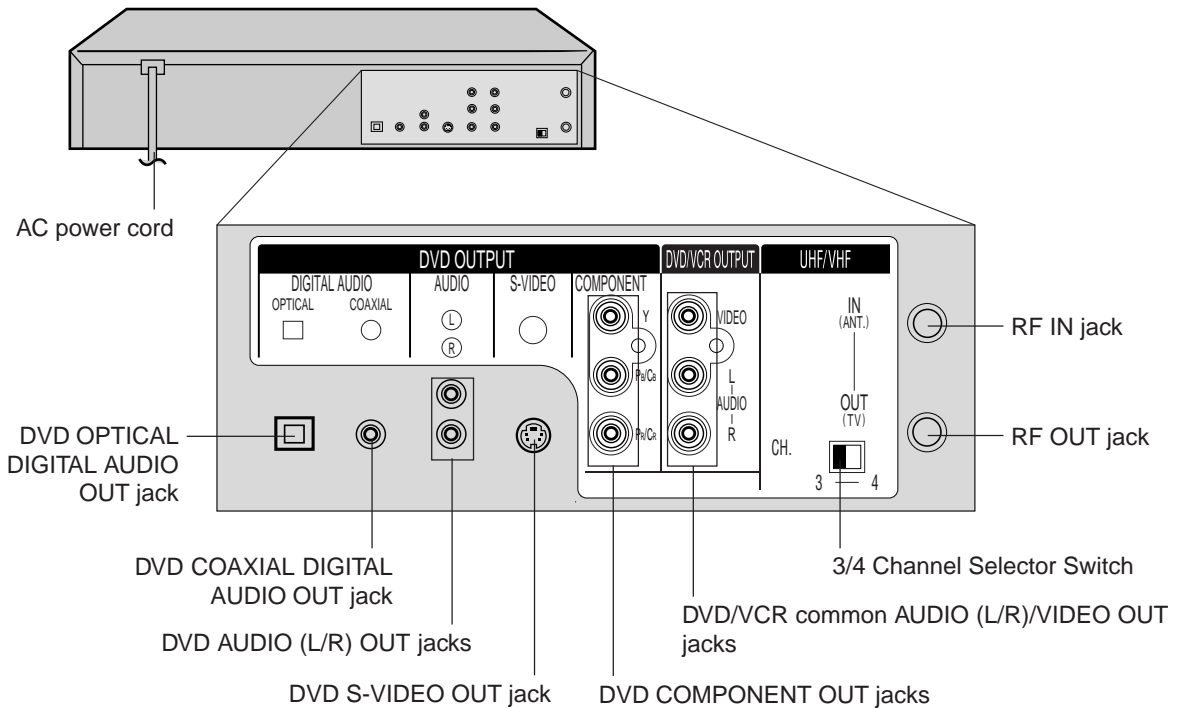

Display window

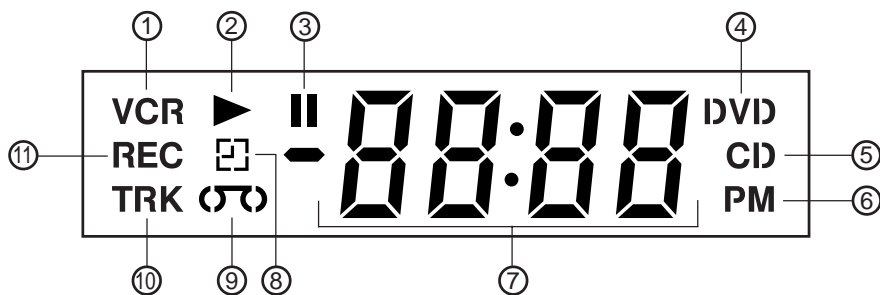

No.	Display	Description
①	VCR	VCR mode
②	▶	Playback (lights) / Auto resume (flashes)
③		Still picture
④	DVD	DVD disc is inserted.
⑤	CD	CD is inserted.
⑥	PM	Display for afternoon (lights out in the morning)
⑦	10 : 00	Clock display (colon[:] flashes)
	01 : 00	Counter display by hour/minute at VCR/DVD / by minute/second at CD
	2	Track number display for CD
	CH02	TV channel display for VCR
	C036	CATV channel display
	L	External input display
⑧	□	Timer recording display
⑨	Ⓜ	Video tape is in the unit
⑩	TRK	Track display for CD
⑪	REC	Normal recording display (flashes during Instant Timer Recording - ITR)

Explanation for On-Screen-Symbol:

▶ Playback	⏮ Skip chapter to reverse direction	🔍 Zoom
■ Stop	⏪ Open or Close the tray	🔒 Parental level locked
Still picture	⏩ Auto resume	🔓 Parental level unlocked
▶ Frame advanced playback	◀▶▶▶ Direction button's mark	📺 Screen size: Normal TV
▶▶ Forward slowmotion	⏮ A-B A-B repeat	📺 Screen size: PAN SCAN
▶▶▶ Fast Forward playback	⋮ Subtitle language	📺 Screen size: WIDE
◀◀ Review playback	🗣 Soundtrack language	🚫 Shows Prohibited act
▶▶ Skip chapter to forward direction	🗣 Angle	🔊 Output sound for Video-CD

Note:

Some discs may be displayed wrong or e.g. chapter number, playback time, etc. may not be displayed.

Remote control



JVC TV Remote Control

This Remote can control some functions (**TV POWER**, **NUMBER(0-9)**, **INPUT**, **TV VOL +/-**, **TV CH +/-** and **ENTER**) of a remote controllable JVC TV by slide **TV/VCR/DVD** switch to TV.

(The **POWER** button on the upper right is not effective for the TV.)

NOTE:

- It's not possible to operate a unit not equipped with a remote sensor.
- This Remote can control a JVC TV only.
- When you operate the VCR or DVD, the **TV/VCR/DVD** switch must be slided to VCR/DVD again. Otherwise the DVD/VCR may not operate properly.
- Since this unit is combined type of DVD and VCR, the remote code of DVD is individual. So please note that the DVD-keys on the RCU of the other JVC RECEIVER/TV is not effective for this unit.

		Page
TV/VCR/DVD switch	Switch to operate TV or VCR or DVD	18,36
POWER	Power on/off	18
DVD MENU	Display menu of DVD software	45
MARKER	Locating desired scene	43
RETURN	Remove DVD set up menu	36,47
OPEN/CLOSE	Open or Close the tray	37
DISPLAY	Change the front Display mode	27
A.TRK	Digital AUTO TRACKING	26
SUB TITLE	Set Subtitle of a DVD disc	44
C. RESET	Reset the counter to 00:00	27
ANGLE	Change playback angle of a DVD disc	45
ZERO RETURN	Stop the tape when the counter reaches 00:00	27
SEARCH MODE	Index for DVD	39
SP/EP	Sets the tape speed for recording	28,30
PLAY MODE	Select playback mode	40,41
ZOOM	Zoom (DVD/VCD)	39
TITLE	Select title of a DVD disc	45
REPEAT A-B	Repeat playback between A and B (DVD/CD)	40
0-9	Direct channel selection of TV	20,28
	Input setting	39,41
	Enter a password	46,47
TIMER	Set the unit to start recording at a preset time.	31,32
TV/VCR	Switches between TV and VCR	18,29
TV POWER	Turn the connected TV on or off	10
INPUT	Switch the connected TV to external mode	10
TV VOL +/-	Adjust the connected TV's volume	10
REW	Rewind/Review playback	25,26,38
PLAY	Playback	25,37
FF	Fast Forward/Forward search playback	25,26,38
REC	Recording	28,30,34
STOP	Stop	25,37
PAUSE	Still picture/Recording pause on/off	26,29,34,38
SKIP ◀▶	Skip chapter to forward or reverse direction	38
INDEX ◀▶▶	Search for the INDEX mark of a tape	27
TV/VCR CH +/-	Select channel of the connected TV or VCR	10,28,30,34
▲ / ▼	Cursor buttons	
SET -/+	Setting buttons	31,32
	Manual tracking buttons in playback mode	26
◀ / ▶	Cursor buttons - To move Up in the VCR menu you press the ▶. To move Down in the VCR menu you press the ◀.	
ENTER	Enter information in the menu	
SELECT	Select option in the menu	
SET UP MENU	Display menu of setup	18,19,36,48-52
CANCEL	Delete Timer program	32
	Cancel input data in the setting mode	23,31,39,41
OSD	Display VCR or DVD operation status	29,52
A.MONITOR	Switches sound between mono and stereo	33
	Change sound track language of DVD	44
SLOW	Slowmotion playback	26,38
SKIP SEARCH	Skip the unwanted short material of a tape	26

Inserting Batteries

- 1** Open the battery compartment cover in the direction of the arrow.

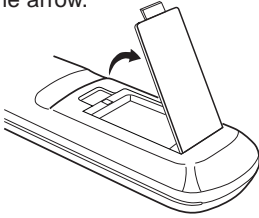

- 2** Install two "AA" batteries (supplied), paying attention to the polarity diagram in the battery compartment.

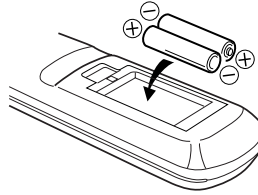

- 3** Replace the compartment cover.

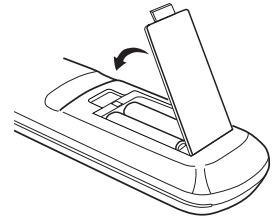

Battery precautions

The precautions below should be followed when using batteries in this device:

1. Use only the size and type of batteries specified.
2. Be sure to follow the correct polarity when installing the batteries as indicated in the battery compartment. Reversed batteries may cause damage to the device. To avoid a potential short circuit, insert the "–" end first.
3. Do not mix different types of batteries together (e.g. Alkaline and Carbon-zinc) or old batteries with fresh ones.
4. If the device is not to be used for a long period of time, remove the batteries to prevent damage or injury from possible battery leakage.
5. Do not try to recharge batteries not intended to be recharged; they can overheat and rupture. (Follow battery manufacturer's directions.)

Remote control basics

- Press **POWER** to turn the DVD/VCR on or off.
- Make sure **TV/VCR/DVD** switch is set to VCR/DVD.
- Tap **VCR CH +** or **VCR CH –** to move through the channels one channel at a time.
- The **VCR CH +/-** and **SET +/-** are also used to navigate on-screen menu system.
- You can directly access specific channels using **Number keys** pad.
- Each press of **VCR** or **DVD**, switches the screen between the VCR screen (VCR mode) and the DVD screen (DVD mode).

Operation

- Aim the remote control at the remote sensor and press control buttons to operate.
- Operate the remote control within 30° angle on either side of the remote sensor, up to a distance of Approx. 5 meters.

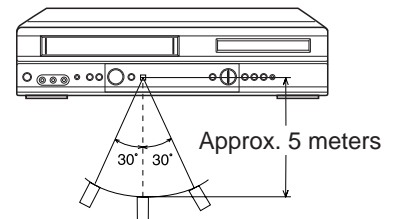

Change the custom code for remote control

If you operate this DVD/VCR with another JVC's VCR simultaneously arranging them side by side, the both recorders will react to this remote control. In this case, you can change the remote control and DVD/VCR to other frequency ("□"). Then you can operate only this DVD/VCR with this changed remote control. When you purchased, the DVD/VCR and remote control have been set to the frequency-"□".

Example: Change frequency to □

Remote control:

While holding **VCR**, press **2**(code: b) of **Number keys**. (in case of code: A, press **1**)

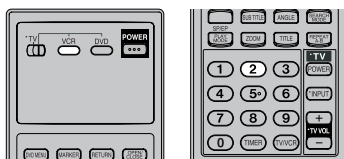

DVD/VCR:

In the **POWER** off mode, press and hold **PLAY** for more than 5 seconds. "b" will appear on the display and then disappear after approx. 4 seconds.

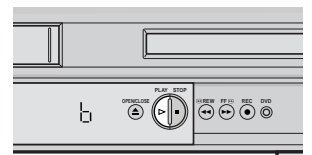

NOTES:

- If the remote control has been set to b, the DVD/VCR also must be set to b. Otherwise, the DVD/VCR can not be operated with this remote control.
- To reset to "A", repeat above procedure. However press **1** instead of **2**.

Basic connections

If you are using an antenna system, follow these instructions. If you are a cable (CATV) subscriber, skip ahead to page 14 for the proper connections.

ANTENNA TO DVD/VCR CONNECTION

The DVD/VCR must be connected "between" the antenna and the TV. First, disconnect the antenna from the TV and connect it to the DVD/VCR. Then connect the DVD/VCR to the TV. Below are 3 common methods of connecting an antenna system to a DVD/VCR. Find the type of antenna system you are using and follow the connection diagram.

1

Combination VHF/UHF Antenna with 75 ohm Coaxial Cable

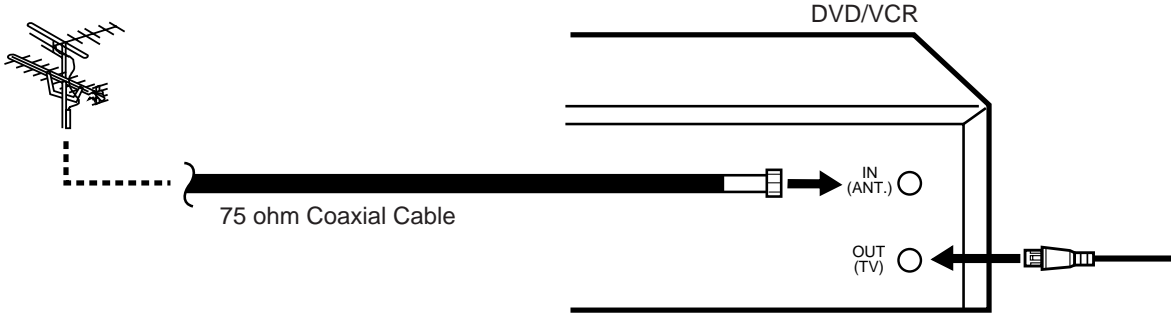

2

Combination VHF/UHF Antenna with 300 ohm Twin Lead (Flat) Wire

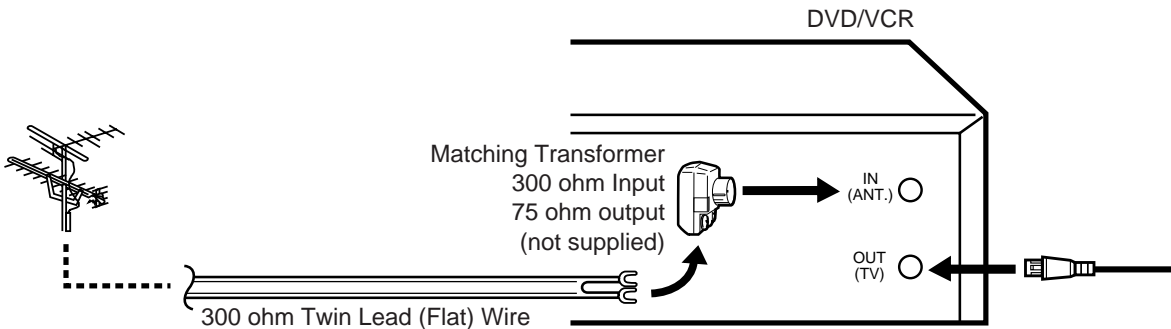

3

Separate VHF and UHF Antennas

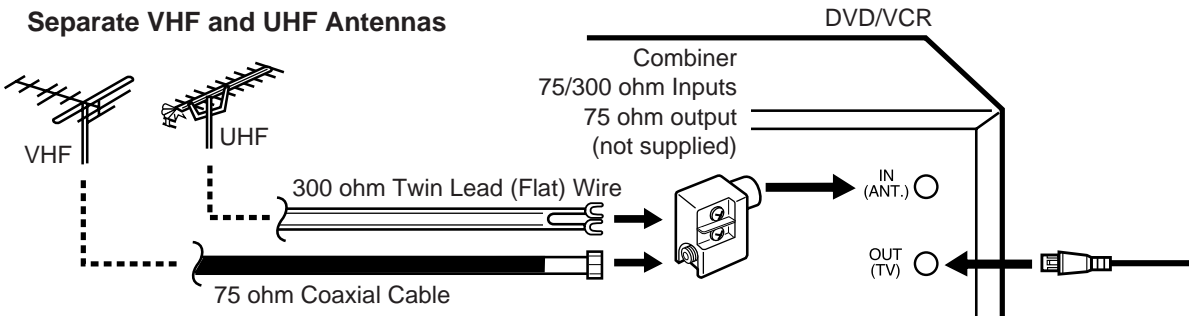

NOTE: If both VHF and UHF antennas have 300 ohm twin lead (flat) wires, use a combiner having two 300 ohm inputs and one 75 ohm output.

- NOTES:**
- A clear picture will not be obtained by the DVD/VCR unless the antenna signal is good. Connect the antenna to the DVD/VCR properly.
 - For better quality recording, an indoor antenna or a telescopic antenna is not recommended. The use of an outdoor type antenna is required.
 - If you are not sure about the connection, please refer to qualified service personnel.

DVD/VCR TO TV CONNECTION

After you have connected the antenna to the DVD/VCR, you must connect the DVD/VCR to the TV. Below are 3 common methods of connecting your DVD/VCR to a TV. Find the type of TV you are using and follow the connection diagram.

This DVD/VCR has a single 75 ohm output for connection to a TV. If your TV has separate VHF and UHF antenna inputs (numbers 2 and 3 below), use a splitter to connect the DVD/VCR to the TV for VHF and UHF reception.

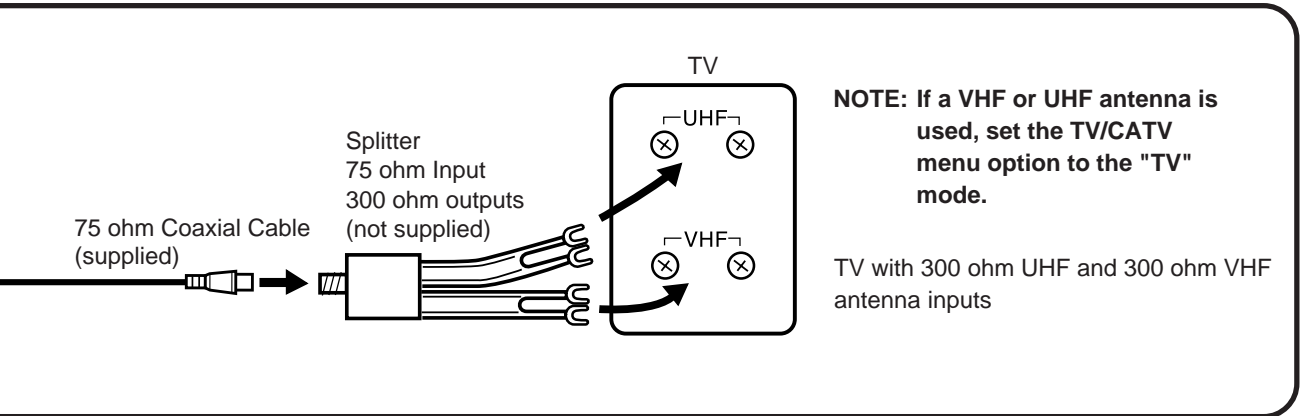
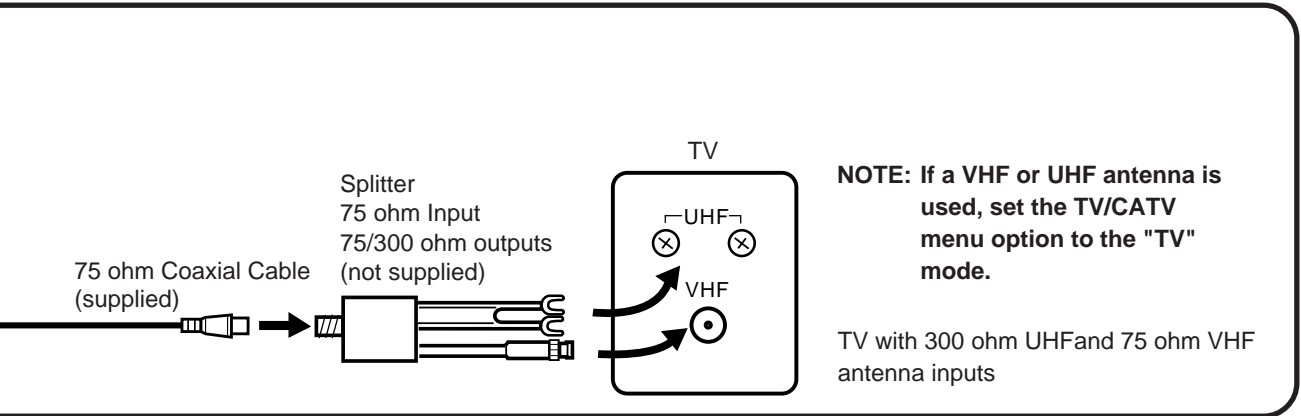
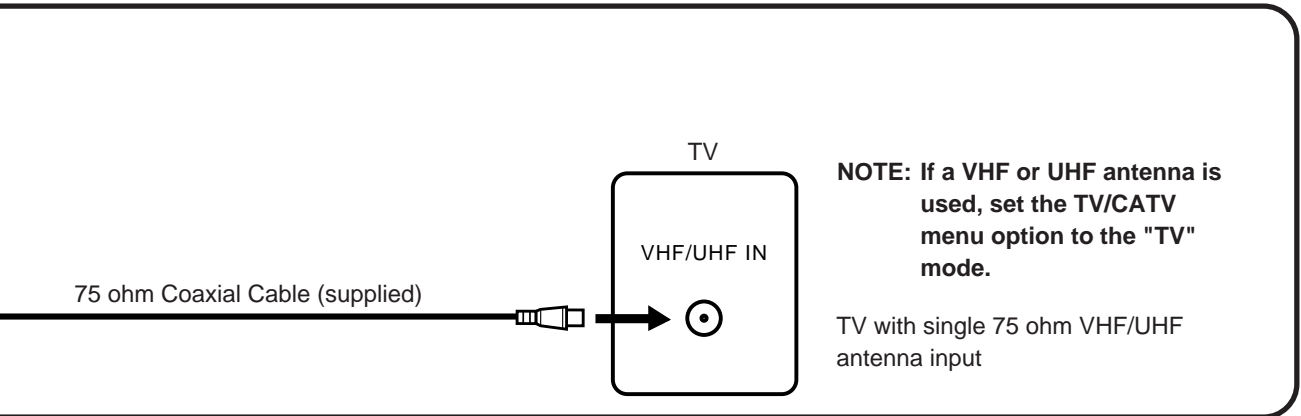

CATV (CABLE TV) connections

Many cable companies offer services permitting reception of extra channels including pay or subscription channels. This DVD/VCR has an extended tuning range and can be tuned to most cable channels without using a cable company supplied converter box, except for those channels which are intentionally scrambled. If you subscribe to a special channel which is scrambled, you must have a descrambler box for proper reception.

1

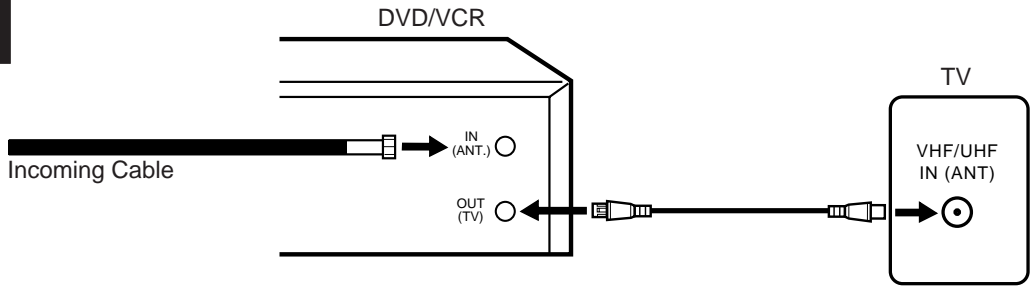

DVD/VCR

IN (ANT.)

OUT (TV)

Incoming Cable

TV

VHF/UHF IN (ANT)

ALLOWS:

- * Recording of nonscrambled channels.
- * Use of the programmable timer.
- * Recording of one channel while watching another.

2

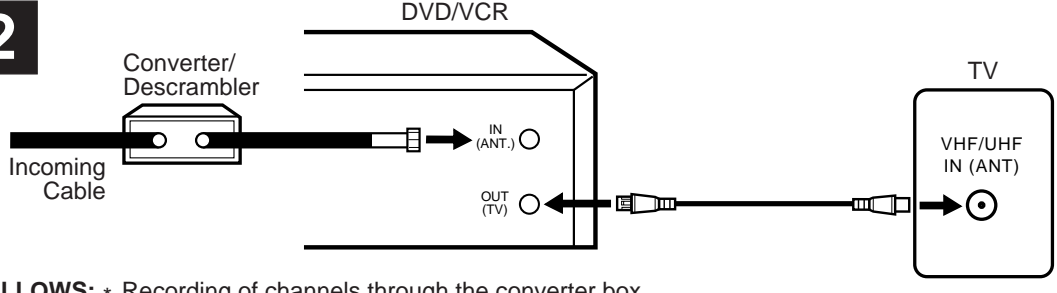

DVD/VCR

IN (ANT.)

OUT (TV)

Incoming Cable

Converter/Descrambler

TV

VHF/UHF IN (ANT)

ALLOWS:

- * Recording of channels through the converter box (scrambled and unscrambled).
- * Using the programmable timer to record only the channel selected at the converter box.

PREVENTS:

- * Recording one channel while watching another.
- * Using the DVD/VCR tuner to select channels.

NOTE:

To record from converter/descrambler, DVD/VCR tuner must be tuned to the converter output channel, usually channel 3 or 4.

3

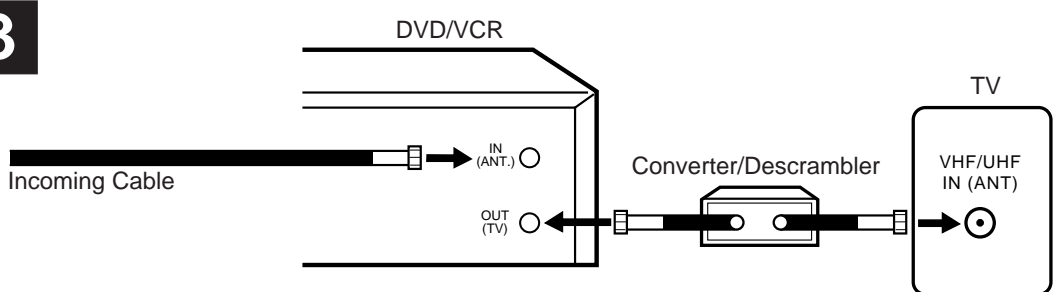

DVD/VCR

IN (ANT.)

OUT (TV)

Incoming Cable

Converter/Descrambler

TV

VHF/UHF IN (ANT)

ALLOWS:

- * Recording of nonscrambled channels.
- * Use of the programmable timer.
- * Recording an unscrambled channel while watching any channel selected at the converter box.

PREVENTS: Recording scrambled channels.

NOTE:

If you are playing a tape or using the tuner built into the DVD/VCR, the converter must be set to the video channel output of the DVD/VCR (either 3 or 4).

NOTE: Whenever a Converter/Descrambler box is placed before the DVD/VCR, you must tune the DVD/VCR to the output of the Converter/Descrambler box, usually channel 3 or 4.

CATV (CABLE TV) connections

IMPORTANT: Make sure the TV/CATV menu option is set to the "CATV" mode.

This DVD/VCR cannot receive scrambled programs since it does not contain a descrambler. In order to receive scrambled programs, your existing descrambler must be used. Descrambler boxes are available from cable companies. Consult your local cable company for more information concerning connection to their descrambler equipment. There are many ways to connect your DVD/VCR to a cable system. Below are six common methods of connection.

4

ALLOWS:

- * Recording of one channel while watching another.
- * Using the programmable timer to record only the channel selected at the converter box.
- * Recording of all channels through the converter box.

PREVENTS:

- * Watching scrambled channels while recording another channel.
- * Using the DVD/VCR tuner to select channels.

5

ALLOWS:

- * Recording of nonscrambled channels.
- * Recording of one channel while watching another.
- * Watching premium channels through the converter while recording nonscrambled channels.
- * Using the programmable timer.

PREVENTS: Recording scrambled channels.

6

ALLOWS:

- * Recording of all channels through the converter box.
- * Recording a scrambled or unscrambled channel while watching another (scrambled or unscrambled) channel.
- * Using the programmable timer to record only the channel selected at the converter box.

PREVENTS: Using the DVD/VCR tuner to select channels.

Playback Connection

The exact arrangement you use to interconnect various video and audio components to the DVD/VCR is dependent on the model and features of each component. Check the Owner's Manual provided with each component for the location of video and audio inputs and outputs.

Connect to a TV with Audio/Video Output

Use the supplied AUDIO/VIDEO Cord.

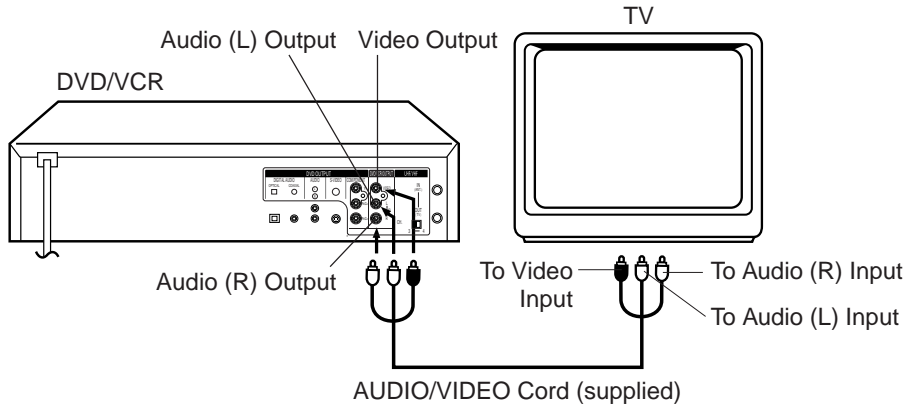

Connect to a TV with S-Video Output

You can use the following connection only for DVD/CD playback.

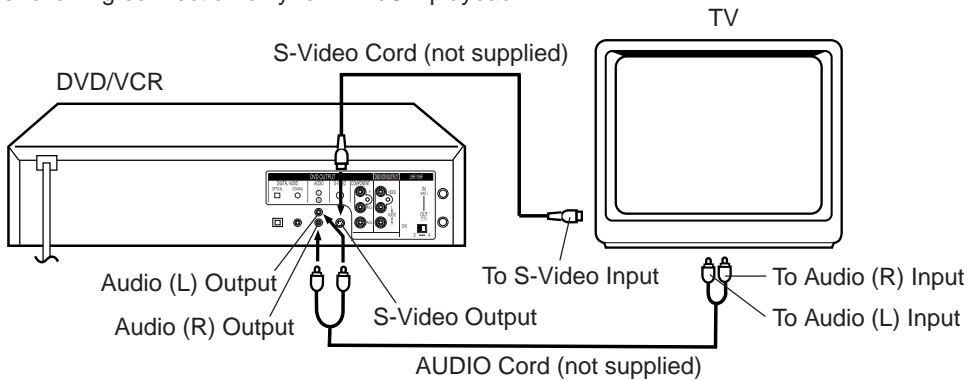

Connect to a BS TUNER

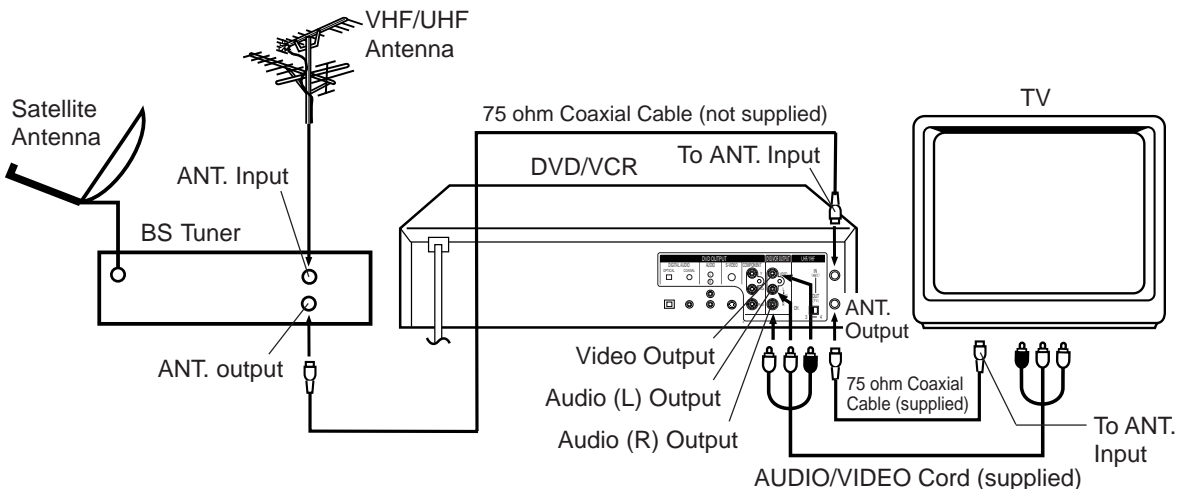

Connect to a Stereo Amplifier with Audio Output

If your TV has a COMPONENT VIDEO IN jack, you can connect the DVD/VCR to the TV with a COMPONENT cable (not supplied) as shown below. COMPONENT VIDEO output jack can send higher-quality video signal to a TV than S-Video output.

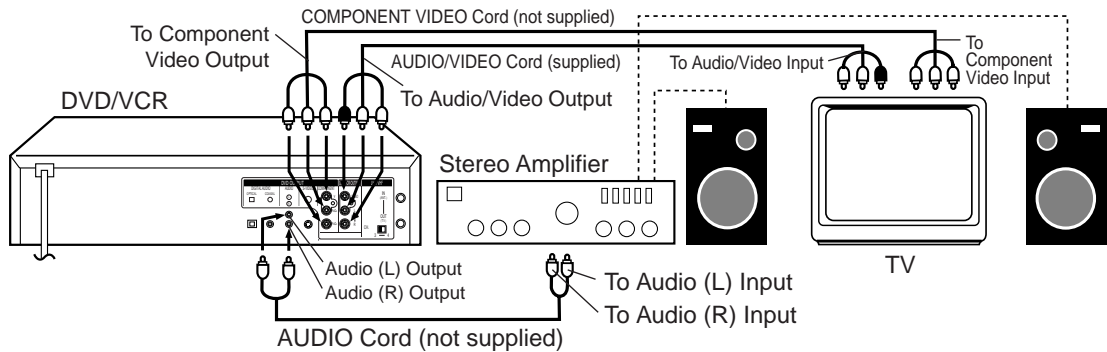

Connect to an AV Amplifier with built-in digital surround

If you are using an Amplifier with a built-in digital surround as follows, you can enjoy the various audio systems such as Dolby Digital and DTS by using the Optical or Coaxial Digital Output.

Use this connection to connect an:

- AV amplifier with built-in *Dolby Digital decoder
- AV amplifier with built-in *DTS decoder

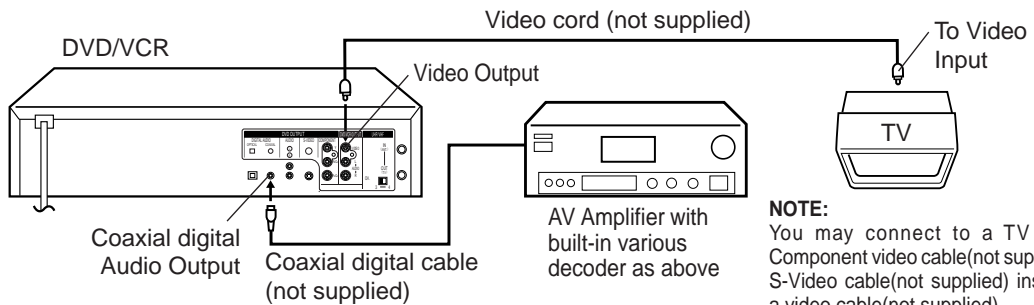

NOTE:
You may connect to a TV with a Component video cable(not supplied) or S-Video cable(not supplied) instead of a video cable(not supplied).

Connecting the optical digital cable

You may connect to an AV Amplifier with an Optical digital cable (not supplied) instead of a Coaxial digital cable.

When you connect the optical digital cable (not supplied), remove the dust protection cap from the rear panel. When not using the optical digital cable, attach the dust protection cap to protect against dust.

NOTES:

- The OPTICAL, COAXIAL, AUDIO L/R, S-VIDEO and COMPONENT jacks are useful only for DVD section. The VHS signal is output only from the composite jack(DVD/VCR VIDEO OUTPUT) and UHF/VHF OUT.
- When you make the connections above, do not set DOLBY DIGITAL to DOLBY DIGITAL or DTS to ON on the AV Amplifier. If you do, a loud noise will suddenly come out from the speakers, affecting your ears or causing the speakers to be damaged.
- Caution for the **optical** digital audio output connector: Do not connect to an amplifier (with an optical digital input connector) which does not contain a Dolby Digital or DTS decoder. Otherwise, any attempt to play DVDs may cause such a high level of noise that it may be harmful to your ears and damage your speakers.
- DTS audio will be output only from the COAXIAL or OPTICAL output. To hear DTS audio, DTS-Decoder is necessary.
- When playing DTS-encoded CDs, only noise will be heard from the speakers or analogue stereo outputs.
- Some DTS decoders which do not support DVD-DTS interface may not work properly with the unit.

Setting the Video Channel / Setting the language

Setting the Video Channel

To view playback of a recorded tape, or to watch a program selected by the VCR's channel selector, the TV must be set to channel 3 or 4 (video channel).



NOTES:

- If the unit does not operate properly, or No key operation (by the unit and/ or the remote control): Static electricity, etc., may affect the player's operation. Disconnect the AC power cord once, then connect it again.
- If no buttons are pressed for more than 60 seconds, the MENU screen will return to normal TV operation automatically.
- Both the VCR and the DVD have their own menu options (See page 36).

When a TV is connected with the 75 ohm coaxial cable only.

- 1 Press **POWER** to turn on the DVD/VCR.
- 2 Slide **TV/VCR/DVD** switch to VCR/DVD. Then press **VCR** to select the VCR mode. The VCR indicator on the front panel will light.
- 3 Set the **3/4 Channel selector** switch on the rear panel to CH 3 or 4.
- 4 Turn ON the TV and set to CH 3 or 4 to correspond with the channel selected in step 3.
- 5 Press **TV/VCR** to select the VCR position. The VCR indicator will appear in the display.
- 6 Select any channel to receive a TV station in your area. The channel number will appear on the screen for about 4 seconds.

For a push-button TV tuner

If CH 3 or 4 corresponding to the video channel cannot be tuned on your TV, proceed as follows: set the VCR 3/4 channel selector and the TV to CH 3 or 4, play back a prerecorded tape and tune the TV to receive a sharp color picture from the video cassette recorder. Refer to your TV owner's manual for details.

Setting the language

You can choose from three different languages (English, French and Spanish) for the on-screen displays.

- 1 Press **SETUP MENU**, If you use the unit for the first time and press **SETUP MENU**, instead of the main menu screen on the right the **SYSTEM SET UP** menu screen in step 2 may appear.

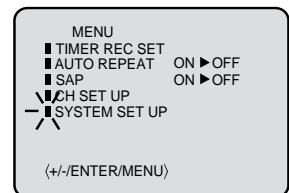

- 2 Press **◀** or **▶** to select the "LANGUAGE" option, then press **ENTER**.

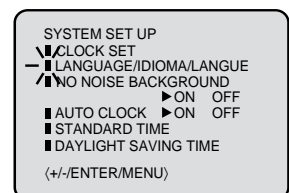

- 3 Press **◀** or **▶** to select the desired language: English (ENGLISH), Spanish (ESPAÑOL) or French (FRANCAIS), then press **ENTER**.

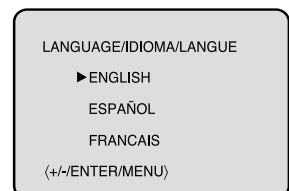

- 4 Press **SETUP MENU** until the MENU screen is cleared.

Tuner Setting

This DVD/VCR is equipped with a channel memory feature which allows channels to skip up or down to the next channel set into memory, skipping over unwanted channels. Before selecting channels, they must be programmed into the DVD/VCR's memory. In addition to normal VHF and UHF channels, this DVD/VCR can receive up to 113 Cable TV channels. To use this DVD/VCR with an antenna, set the TV/CATV menu option to the TV mode. When shipped from the factory, this menu option is in the CATV mode.



NOTE:
You can not select "CH SET UP" if you set the channel to "L".

Preparation:

- Turn ON the TV and set it to the video input mode.
- Make sure **TV/VCR/DVD** switch has been slid to VCR/DVD. Then press **VCR** to select the VCR mode. (The VCR indicator will light.)

TV/CATV Selection

1 Press **SETUP MENU**. The VCR menu screen will appear. Press **◀** or **▶** to select CH SET UP, then press **ENTER**.

2 Press **◀** or **▶** to select the "TV/ CATV" option.

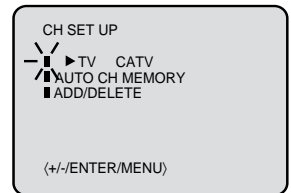

3 Then press **ENTER** to select the TV or CATV mode. The arrow indicates the selected mode.

TV - VHF/UHF channels
CATV - CABLE TV channels

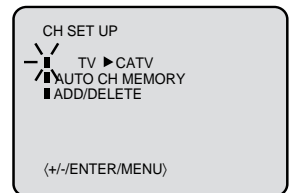

4 Press **SETUP MENU** until the menu screen is cleared.

Setting channels automatically

The VCR can receive a maximum of 181 channels by presetting the channels into memory.

1 Repeat above step 1 and press **◀** or **▶** to select **AUTO CH MEMORY**.



2 Then press **ENTER**. The auto tuning will start. The channel display will count up and when finished, the screen returns to normal.

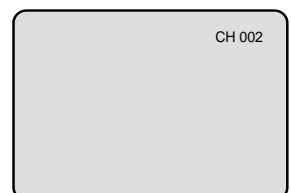

To ADD/DELETE channels / Noise elimination

To ADD/DELETE channels

You can add the channels you want or delete the channels you do not want manually.



Preparation:

- Turn ON the TV and set it to the video input mode.
- Make sure **TV/VCR/DVD** switch has been slid to VCR/DVD. Then press **VCR** to select the VCR mode. (The VCR indicator will light.)

- 1 Repeat the step 1 on page 19. Then press ◀ or ▶ to select the "ADD/DELETE" option and press **ENTER**.



2 To Add or Delete desired channels

- 1 Press **Number keys** or ◀/▶ to select a channel number you want to add or delete.

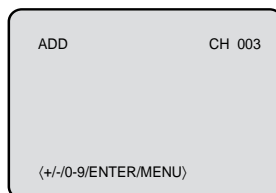

- 2 **To add channels**
Press **ENTER** until "ADD" appears on the screen to set to add the unmemorized channel.

To delete channels

Press **ENTER** until "DELETE" appears on the screen to set to delete the channel from memory. The channel number will blink.

- 3 Repeat 1 to 2 to add or delete other channel.

3 Press **SETUP MENU** until the menu screen is cleared.

Noise elimination

When you don't want to receive a weak signal broadcast, the Blue back screen can be obtained by selecting the **NO NOISE BACKGROUND "ON"**. When the unit is shipped from the factory, the **NO NOISE BACKGROUND** is set to the "ON".

- 1 Repeat the steps 1~2 on page 18 and press ◀ or ▶ to select **NO NOISE BACKGROUND**.

- 2 Press **ENTER** to select the ON position.

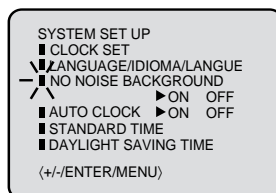

- 3 Press **SETUP MENU** until the menu screen is cleared.

Auto clock setting

The Auto Clock feature enables the automatic clock setting and updating, and also to set the Time Zone and Daylight Saving Time by receiving XDS (Extended Data Service) information carried on the channel signal.



NOTES:

- After Auto Clock setting, in some case the clock may display the other time zone's. You can correct the clock by selecting your Time Zone setting above.
- When the clock is not set or you set the clock manually, Time Zone setting is not available.

Preparation:

- You must set the antenna connection before the AC cord plug is inserted into the AC outlet.
- Make sure the AUTO CH MEMORY (on P.19) is done.

Auto clock setting

WAIT 30 MINUTES! when the power switch is off, after the connections of the antenna and the power plug. Because the Auto Clock setting feature is activate.

After the clock is set automatically, you may have to set the Time Zone and Daylight Saving Time.

Press **POWER** to turn on the DVD/VCR after the Auto Clock operation completed.

- When shipped from factory, the AUTO CLOCK option is set to ON position.
- If you turn the DVD/VCR on during Auto Clock setting, the clock is not set.
- With cable box connection, if the Auto Clock Setting is unsuccessful, please select the PBS channel carrying the XDS information, then turn the DVD/VCR off. After 30 minutes, turn the DVD/VCR on, and if the clock is not set automatically, set the clock manually. (See page 23)

Canadian Viewers:

Please see note regarding the Auto Clock Setting option on page 55.

Time Zone setting (STANDARD TIME)

In the rare event that you live within broadcast range of two stations in two different time zones, the DVD/VCR may recognize the wrong station for the AUTO CLOCK set.

To correct the situation:

Preparation:

- Turn ON the TV.
- When a TV is connected with an audio/video cable, select the video input mode on the TV.
- When a TV is connected only with an antenna cable, set to the video channel 3 or 4. Then select VCR position with **TV/VCR**.
- Make sure the VCR mode has been selected. (Is the VCR indicator being light?) (see steps 1~2 on page 18)

1 Press **SETUP MENU**. The VCR menu screen will appear. Press **◀** or **▶** to select the SYSTEM SET UP menu, then press **ENTER**.

2 Press **◀** or **▶** to select the "STANDARD TIME" option, then press **ENTER**.

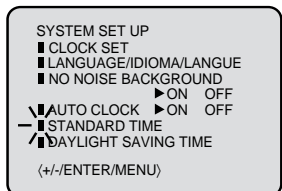

3 Press **◀** or **▶** to select your Time Zone, then press the **ENTER**.

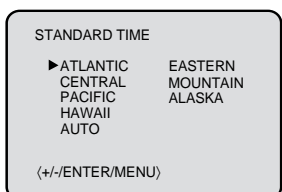

4 Press **SETUP MENU** until the MENU screen is cleared.

Auto clock setting

Daylight saving time setting

You can set the Daylight saving time automatically or manually.



Preparation:

- Turn ON the TV.
- When a TV is connected with an audio/video cable, select the video input mode on the TV.
- When a TV is connected only with an antenna cable, set to the video channel 3 or 4. Then select VCR position with **TV/VCR**.
- Make sure **TV/VCR/DVD** switch has been slid to VCR/DVD. Then press **VCR** to select the VCR mode. (The VCR indicator will light.)

- 1 Repeat the step 1 on page 21 and press ◀ or ▶ to select DAYLIGHT SAVING TIME, then press **ENTER**.

```
SYSTEM SET UP
■ CLOCK SET
■ LANGUAGE/IDIOMA/LANGUE
■ NO NOISE BACKGROUND
  ▶ ON OFF
■ AUTO CLOCK ▶ ON OFF
■ STANDARD TIME
- DAYLIGHT SAVING TIME
  / \
  (+/-/ENTER/MENU)
```

- 2 Press ◀ or ▶ to select one of the options, then press **ENTER**.

- ON:** for manual setting
(forward one hour)
- OFF:** for manual setting
(back one hour)
- AUTO:** for automatic setting
(read XDS in the signal)

```
DAYLIGHT SAVING TIME
ON
OFF
▶ AUTO
(+/-/ENTER/MENU)
```

When you want to set the Daylight Saving Time manually, on the first Sunday in April you set to "ON", and on the last Sunday in October you set to "OFF".

NOTES:

- When shipped from factory, the DAYLIGHT SAVING TIME option is set to AUTO position.
- When the clock is not set, Daylight Saving Time setting is not available.
- When there is no Daylight Saving Time in your area, always select OFF position in step 2.

Manual clock setting

You must set the date and time manually for timer recordings and Daylight Saving Time if the Auto Clock process did not set them correctly.



NOTE:
After a power failure or disconnection of the power, the timer settings will be lost. In this case, reset the present time.

Preparation:

- Turn ON the TV and set to the video input mode.
- Make sure **TV/VCR/DVD** switch has been slid to VCR/DVD. Then press **VCR** to select the VCR mode. (The VCR indicator will light.)

EXAMPLE: Setting the clock to "8:30 AM" October, 26 (SAT), 2002.

1 Press **SETUP MENU**. The VCR menu screen will appear.

2 Press **◀** or **▶** to select the **SYSTEM SET UP** menu, then press **ENTER**.

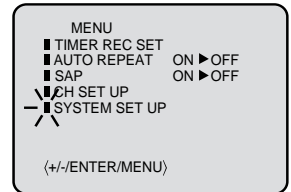

3 Press **◀** or **▶** to select the "CLOCK SET" option, then press **ENTER**.

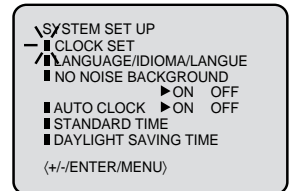

4 Press **◀** or **▶** to set the month, then press **ENTER** button.

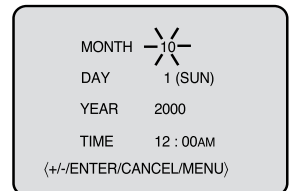

To make corrections any time during the process

Press **CANCEL** repeatedly until the item you want to change blinks, then press **◀** or **▶**.

5 Set the day, year and time as in step 4.

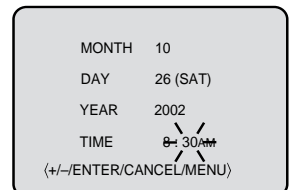

6 After setting the clock, date and time starts functioning automatically.

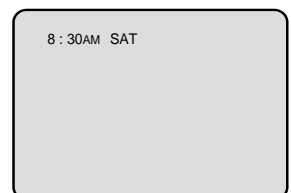

Loading and Unloading a Cassette Tape

Use only video cassette tapes marked **VHS** and **S-VHS**.

SQPB

- Cassettes marked "VHS" (or "S-VHS") can be used with this video cassette recorder. However, S-VHS recording is not possible with this model.
- This model is equipped with SQPB (S-VHS QUASI PLAYBACK) that makes it possible to play back S-VHS recordings with regular VHS resolution.
- HQ VHS is compatible with existing VHS equipment.

Loading

Push the center of the tape until it is automatically inserted.

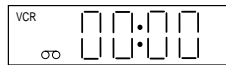
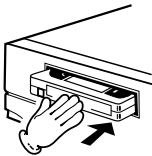

Insert the cassette tape with its labeled side facing up and the erase prevention tab positioned at your left. An inverted cassette tape cannot be inserted.

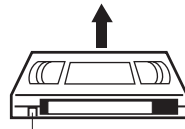

Erase prevention tab

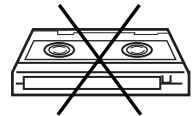

Automatic power ON

When you insert a cassette tape the VCR power will turn ON automatically.

Automatic playback

When loading a cassette tape without an erase prevention tab, playback will start automatically.

Unloading

1 Press **EJECT** on the unit.



2 Remove the cassette tape.

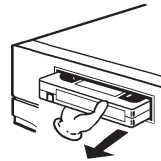

Automatic tape eject

This VCR will automatically rewind the tape when the tape has ended. And when the tape is rewinded to its beginning, the cassette tape will be ejected automatically.

To prevent accidental erasure

Remove the erase prevention tab with a screwdriver.



To record again

Cover the hole with a piece of adhesive tape.



Tape speed and maximum recording time

Tape Speed	Video cassette tape				
	T-160	T-120	T-90	T-60	T-30
SP (Standard Play)	2-2/3 hours	2 hours	1-1/2 hours	1 hour	30 minutes
EP (Extended Play)	8 hours	6 hours	4-1/2 hours	3 hours	1-1/2 hours

Cassette tape Playback



NOTES:

- This VCR selects the playback tape speed SP or EP automatically.
- The Cassette tape and DVD disc can be played back simultaneously. If you press **VCR** or **DVD**, the tape playback and DVD playback alternate with each other on the screen.

Preparation:

- Turn ON the TV and set to the video input mode.
- Make sure **TV/VCR/DVD** switch has been slid to VCR/DVD. Then press **VCR** to select the VCR mode. (The VCR indicator will light.)

- 1 Load a prerecorded tape (When loading a cassette tape without the erase prevention tab, playback will start automatically).

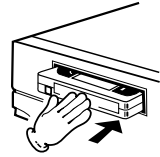

- 2 **To start playback**
Press **PLAY**.
Playback will start.
"▶" will appear on the screen for about 4 seconds.

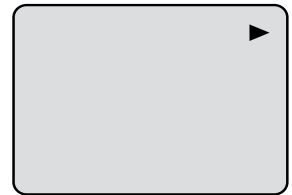

- To stop playback**
- Press **STOP** once.
The tape will stop but remain fully loaded and ready to play.
"■" will appear on the screen for about 4 seconds.



To rewind the tape or forward it rapidly

Stop the playback or recording with **STOP**.

To rewind the tape:

Press **REW**.

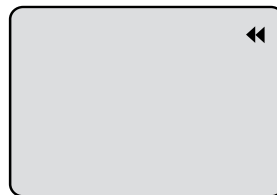

To forward the tape:

Press **FF**.



To stop the tape-winding, press **STOP**. To switch to playback directly (without **STOP**), press **PLAY**.

Forward/Reverse picture search mode

When the tape is being wound, you can switch to picture search mode (see next page). To do this, press **REW** or **FF** and hold it down. The unit will resume the tape winding as soon as the button is released.

Special playback

Picture Search

Reverse picture search function

Press **REW** x 1 or x 2 during the playback.

Forward picture search function

Press **FF** x 1 or x 2 during the playback.

To return to playback: Press **PLAY**.

Still Picture

Press **PAUSE** during playback. To resume normal playback: Press **PLAY**.

Slow Motion

During playback press **SLOW**.

To return to playback: Press **PLAY** or **SLOW**.

Slow tracking and vertical lock adjustment

If noise bars appear in the picture during slow motion, press the **SET +** or **-** to reduce the noise bars. If the still picture jitters excessively, press **SET +** or **-** to stabilize the still picture.

Frame by Frame picture

Press **PAUSE** during playback.

Press **SLOW** one by one: The picture advances frame by frame.

To return to playback: Press **PLAY** or **PAUSE**.

Adjusting tracking condition

Automatic tracking adjustment

Whenever you insert a tape and start playback, automatic tracking starts working and continuously analyzes the signal to enable optimum picture quality during playback.

Manual tracking adjustment

If automatic tracking cannot eliminate noises well during playback, press **SET +/-** to eliminate the noises. "MANUAL TR." will appear. Press it briefly for a fine adjustment, or press and hold for a coarse adjustment.

- Press **A.TRK** to reactivate automatic tracking again. "AUTO TR." will appear.

Notes:

- The audio output is muted during **SPEED SEARCH**, **STILL**, **FRAME ADVANCE** and **SLOW MOTION**.
- During picture search mode there will be noise bars which are caused by the system.
- The Special Playback will automatically change to playback after approx. 5 minutes to protect the video tape against excessive wear.

Repeat playback

The entire video tape will be played until its end. The tape will then automatically rewind to the beginning and the playback will be repeated.

- 1 Press **SETUP MENU**. Press **◀** or **▶** to select **AUTO REPEAT**.

- 2 Then press **ENTER** to select **[ON]** or **[OFF]**. If **[ON]** is selected, the playback will be repeated endlessly.

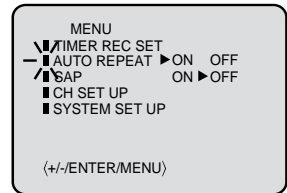

- 3 Press **SETUP MENU** until the menu screen is cleared. if you press **OSD**, "↻" will appear on the screen.

- 4 To start the playback, press **PLAY**. The playback will be repeated endlessly.

To cancel repeat mode:

Follow the above step 1, then press **ENTER** to select the **OFF** position. Press **SETUP MENU** to return to the TV.

Skip Search

Each time you press **SKIP SEARCH** while a tape is playing, the unit will fast-forward ahead 30 seconds on the tape. You may press the button up to six times in a row to move 180 seconds (three minutes) ahead.

- For example: 1 press: 30 seconds of tape
2 presses: 60 seconds of tape
3 presses: 90 seconds of tape

ZERO RETURN function / Video Index Search system

ZERO RETURN function

This function makes tape-rewinding stop at the counter 00:00:00 position automatically.



Preparation:

- Turn ON the TV and set it to the video input mode.
- Make sure **TV/VCR/DVD** switch has been slid to VCR/DVD. Then press **VCR** to select the VCR mode. (The VCR indicator will light.)

1 Press **OSD**.
The counter display shows the tape running time during playback or recording.

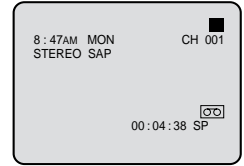

2 Press **C. RESET** at the desired tape position. The counter display will be reset to the "00:00:00" position (e.g. the beginning of recording).

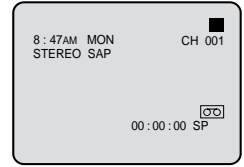

3 Press **STOP** when playback or recording is finished. Press **ZERO RETURN**. The tape will be rewinded or fast forwarded and automatically stop at the "00:00:00" position.

The DISPLAY-button

Press **DISPLAY**. The clock and tape counter alternate with each other in the display.

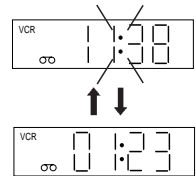

NOTES for Counter Display:

- If you rewind the tape beyond "00:00:00", a minus sign ("-") will be displayed in front of the time counter.
- When you load a tape, the counter will reset to "00:00:00".
- The counter does not function on nonrecorded (blank) sections of the tape. When you rewind, fast forward or play tapes through blank sections, the counter stops.

NOTES for Video Index Search system:

- When you record an **INDEX** mark at the very beginning of the tape, the mark may not be found.
- During **INDEX** search, the tape may stop and begin to play at a slightly different location.
- **INDEX** may not function properly with old or worn out video tapes.
- **INDEX** marks may not be found if it is extremely close to the point where the search began.
- In recording, if you stop recording temporarily, the **INDEX** mark is not recorded on the tape.

Video Index Search system

This function enables you to locate the beginning of any recording made on the VCR.

Recording an INDEX MARK

The Index Search function automatically records an **INDEX** mark on the tape whenever a recording is initiated.

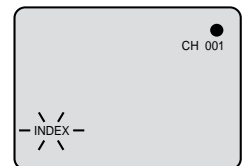

Index Search

Press **INDEX** **▶▶** or **◀◀** during stop or play mode.

For Succeeding programs: Press **INDEX** **▶▶**.
For Preceding programs: Press **INDEX** **◀◀**.
(Additional press increases the **INDEX NO.** up to 9.)

When the **INDEX** **▶▶** or **◀◀** is pressed, the unit starts searching the **INDEX NO.** selected and finds the portion, then playback starts automatically.

To stop the Index Search, press **STOP**.



▶▶ or ◀◀ is displayed
INDEX NO. (up to 9)

Recording a TV program

Recording and viewing the same TV program



NOTE:

- If the erase prevention tab is removed, the tape will eject when both the **REC** and **PLAY** are pressed for recording.
- If you wish to watch the DVD playback during the normal recording on VCR, press **DVD** to change to DVD mode and perform the DVD playback (see P.37).

Preparation:

- Turn ON the TV and set it to the video input mode.
- Make sure **TV/VCR/DVD** switch has been slid to VCR/DVD. Then press **VCR** to select the VCR mode. (The VCR indicator will light.)

- 1 Load a cassette tape with the erase prevention tab intact. The VCR will automatically turn on.

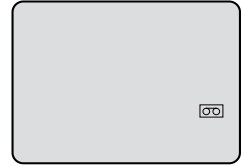

- 2 Press **SP/EP** to select the desired tape speed SP or EP. The tape counter and SP or EP will appear on the screen for about 4 seconds.

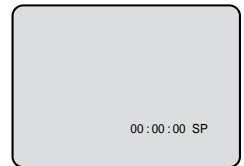

- 3 Set the TV/CATV option to the appropriate position (See page 19).

TV - VHF/UHF channels
CATV - CABLE TV channels

- 4 Press **Number keys** or **VCR CH +/-** to select the channel to be recorded.

- 1-9 Press **0** twice and then **1-9** as required. Example: To select 2, Press "002".
- 10-12 Press **0** first and then the remaining 2 digits in order from left to right. Example: Press **012** for "12".
- 13-99 Press 2 digits in order. Example: Press **22** for "22".
- 100-125 Press the 3 digits in order. Example: Press **110** for "110".

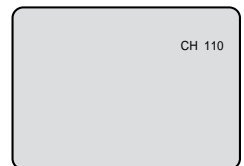

VHF/UHF/CATV CHANNELS

TV	CATV
VHF 2-13	VHF 2-13
UHF 14-69	STD/HRC/IRC 14-36 (A) (W) 37-59 (AA) (WW) 60-85 (AAA) (ZZZ) 86-94 (86) (94) 95-99 (A-5) (A-1) 100-125 (100)(125) 01 (5A)

- 5 On the VCR, press **REC**. Or on the Remote, while holding **REC**, press **PLAY**. "●" will appear on the screen for about 4 seconds and "REC" will appear on the display.

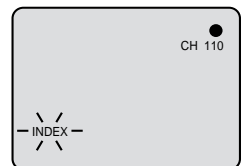

Recording a TV program



To stop recording

Press **STOP** to stop recording.
 "■" will appear on screen for about 4 seconds.



To stop recording temporarily

Press **PAUSE** to avoid recording unwanted material. Press again to continue the recording.
 "●||" will appear on screen for about 4 seconds.



NOTE:

- The pause function will be released after 5 minutes to prevent damage to the tape or the VCR. The VCR will change to the STOP mode.
- You can select a recording channel in the recording pause mode.

Recording one program while watching another

While the VCR is recording, press **TV/VCR** to select the TV position. The "VCR" will go off and recording will continue.

Select the TV channel you want to watch by using the TV channel selector. If the connected TV is JVC's, use **TV CH +/-** after slide **TV/VCR/DVD** switch to TV.

NOTE:

Some CATV hookups do not permit viewing one channel while recording another. See pages 14,15.

To Display VCR operation Status

Press **OSD**. The clock, day of the week and more information will be indicated.

While watching TV

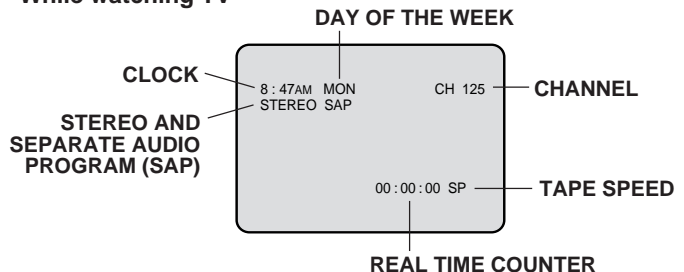

While operating a tape

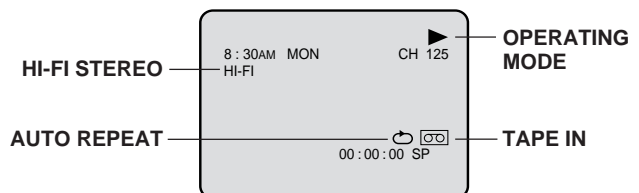

Auto Rewind feature

This VCR will automatically rewind the tape when the tape has ended (except during ITR and TIMER REC). It will also eject the tape.

To cancel the display: Press **OSD** until all indicators disappear.

Instant Timer Recording (ITR)

The Instant Timer Recording feature provides a simple and convenient way to make a timed recording.



NOTE:

If you wish to watch the DVD playback during the ITR, press **DVD** to change to DVD mode and perform the DVD playback (see P.37).

Preparation:

- Turn ON the TV and set it to the video input mode.
- Make sure **TV/VCR/DVD** switch has been slid to VCR/DVD. Then press **VCR** to select the VCR mode. (The VCR indicator will light.)

Example: Instant Timer Recording for 30 minutes.

- 1 Load a cassette tape with the erase prevention tab intact. The VCR will automatically turn on.



- 2 Press **SP/EP** to select the desired tape speed SP or EP. The tape counter and SP or EP will appear on the screen for about 4 seconds.

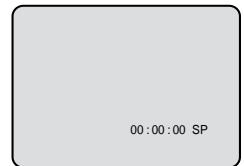

- 3 Set the TV/CATV option to the appropriate position (See page 19).

TV - VHF/UHF channels
CATV - CABLE TV channels

- 4 Press **Number keys** or **VCR CH +/-** to select the channel to be recorded.

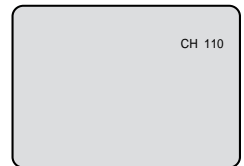

- 5 Press **REC** on the VCR or while holding **REC**, press **PLAY** on the Remote to begin recording. Press **REC** on the VCR again to stop recording after 30 minutes. Each additional press of **REC** will increase recording time as shown in the chart below, up to a maximum of 5 hours. The ITR and recording time will appear on the screen for about 4 seconds. And, REC will keep blinking in the display.

Press	Recording time	Press	Recording time
once	NORMAL REC	6 times	3:00
twice	0:30	7 times	4:00
3 times	1:00	8 times	5:00
4 times	1:30	9 times	NORMAL REC
5 times	2:00		

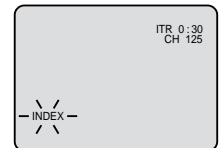

To cancel ITR

Press **STOP** or turn off the power. "■" will appear on screen for about 4 seconds.



Timer Recording

Timer recording can be programmed on-screen with the remote control. The built-in timer allows automatic unattended recording of up to 8 programs within 1 month.

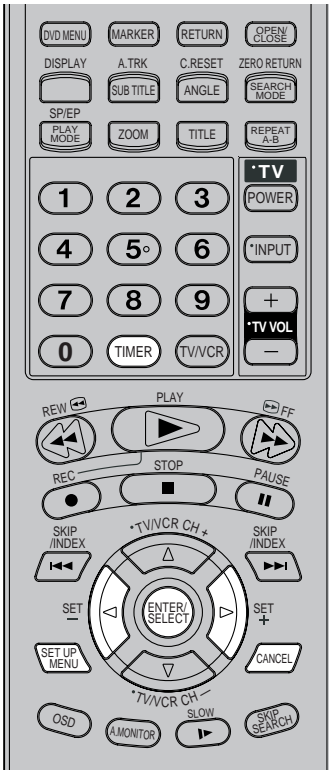

NOTES:

- If the clock symbol (⌚) blinks when the timer recording ended, the TV program has not been completely recorded because of an insufficient tape supply. In this case, press **TIMER** to cancel the timer program or press **EJECT** to remove the cassette tape.
- During timer recording standby mode, the VCR mode cannot be selected. To use the VCR, press **TIMER** at first, then press **VCR** to change to VCR mode. After you use the VCR, press **TIMER** again to put the VCR into timer recording standby mode.
- If you press **TIMER** during timer recording, the recording operation will be interrupted. If you press **TIMER** again within the programmed time, the recording operation will start again.
- After a power failure or disconnection of the power plug, all programmed recording settings and time display will be lost upon resumption of power. In this case, reset the clock (see pages 21-23) and reprogram any timer recordings.

Preparation:

- Make sure **TV/VCR/DVD** switch has been slid to VCR/DVD. Then press **VCR** to select the VCR mode.
- Load a cassette tape with the erase prevention tab intact.
- Press **OSD** to verify that the time and date are correct (see page 29).

Example: Program a timer recording for the 26th day, channel 125 (CATV), 11:00 - 11:30 PM on timer program number 1 (Tape speed: EP).

1 Press **SETUP MENU**. Select the **TIMER REC SET** option, then press **ENTER**.

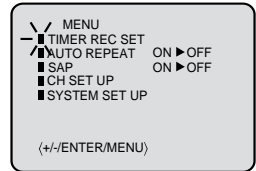

2 Press **SET +** or **-** to select one of the program line, then press **ENTER**.

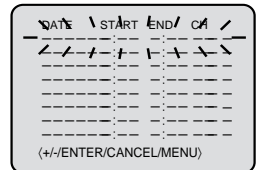

3 Press **SET +** or **-** to select the date, then press **ENTER**.

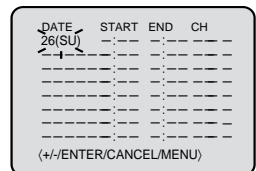

4 Set the **start time, end time, channel** and **tape speed** as in step 3.

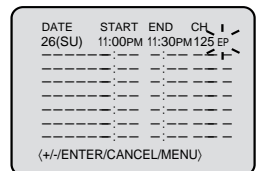

NOTES:

- Press **CANCEL** to move cursor backward for correction.
- To record from external source set the channel to "L". "L" will appear next to CH 125 (or 69).

5 To enter other programs, repeat step 2 through 4.

- To return to the normal screen, press **SETUP MENU** twice.

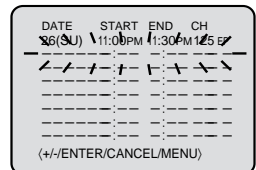

6 Press **TIMER**. The clock symbol (⌚) will appear on the display and the VCR stands by for recording. At the same time, VCR mode will change to DVD mode automatically. You can use DVD even if the VCR is in the Timer recording mode. If you do not use the DVD, turn the power off. The timer recording will start at 5 seconds before the time you predetermined.

NOTES:

- If the clock symbol (⌚) does not appear on the display in spite of the pressing of **TIMER**, the cassette may not have been loaded yet. (see page 24)
- If the cassette is ejected in spite of the pressing of **TIMER**, the erase prevention tab of the cassette may have been removed. (see page 24)

Timer-Recording

Timer Recording Special case

Weekly (e.g. WKL-TU: each Tuesday) or daily (e.g. MO-SA: Monday to Saturday) Timer recording

Follow the procedure of timer recording on the previous page. At picture 3 press **SET +** or **-** repeatedly until the desired setting appears. Then press **ENTER**.

When you press **SET -** repeatedly, the indicator at DATE will change as follows, in this case the today is Friday.

The current day (Friday) → SU-SA (Sunday to Saturday)

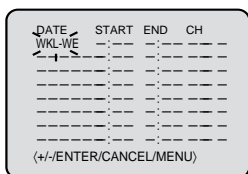
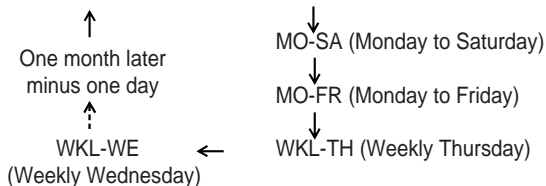

In case Timer programs-overlap

- Do not overlap timer programs as portions of the conflicting programs will be lost. The first recording time has priority over the next recording time as shown in the diagram below.

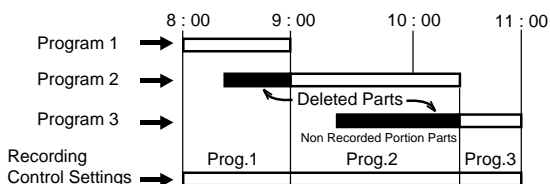

NOTES:

- The daily/weekly recording can be made continuously until the recording is canceled or the tape reaches the end.
- During timer recording the automatic rewinding mechanism does not function.

Confirmation / Cancellation of the Timer Recording

1 If the Timer has been activated, press **TIMER** to deactivate the Timer. The clock symbol(🕒) will disappear. Then press **VCR** to change to VCR mode.

2 To confirm Timer program:

At picture 1 on the previous page select the **TIMER REC SET** option and press **ENTER**.

Then the timer program list as right will appear on the screen.

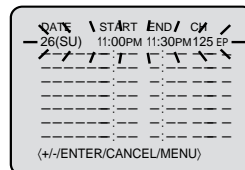

3 To cancel Timer program:

Press **SET +** or **-** to select the unnecessary program, then press **CANCEL** to cancel the program.

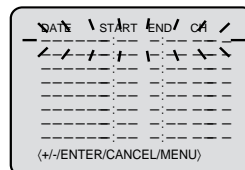

4 Press **SETUP MENU** repeatedly until the TV-picture appears.

NOTES:

- If there are other timer record programs remaining, **TIMER** must be pressed to reactivate the timer, otherwise the remaining timer record programs will be ignored.
- You cannot confirm the Timer program during timer recording operation.
- You can also correct the programmed setting in program confirm mode.

At step 2 above, press **ENTER** to enter the program input mode. Then press **ENTER** repeatedly until the item you wish to correct blinks. Then correct the data with **SET +** or **-**. Then press **SETUP MENU** repeatedly until the TV-picture appears.

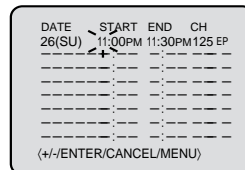

Stereo Recording and Playback / Separate Audio Program (SAP)

Stereo Recording and Playback

The VHS Hi-Fi audio system permits high fidelity recording of MTS STEREO TV broadcasts.



When a MTS STEREO broadcast is received, the word STEREO will appear on the screen and the program can be viewed or recorded in stereo.

The Hi-Fi STEREO recording procedure is the same as for normal recordings.

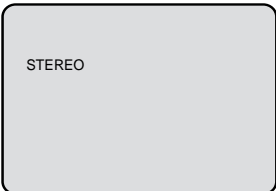

NOTES:

When using a CATV system, stereo TV programs may be transmitted over a mono cable channel. In this case the word "STEREO" will not appear and the sound will be in mono.

Output selection

When viewing an MTS STEREO TV program, or playing a prerecorded VHS Hi-Fi STEREO videotape, press **A. MONITOR** to select how the audio will be heard through the speakers. Normally set to the Hi-Fi STEREO position, this button can be set to the MONO position if the stereo broadcast or videotape audio is of poor quality. The "R" and "L" positions allow the audio from the Right or Left Hi-Fi channel to be heard over both TV speakers. This button has no effect when viewing a MONO videotape or TV program. Each time when you press the button, OUTPUT SELECTION display appears on the screen for several seconds. Refer to the chart below.

OUTPUT SELECTION	SOUND HEARD ON BOTH SPEAKERS
STEREO	STEREO
L ch	LEFT CHANNEL AUDIO
R ch	RIGHT CHANNEL AUDIO
MONO	MONO

Separate Audio Program (SAP)

Your VCR is fitted with a SAP broadcast system which enables you to switch to a separate audio program when viewing a selected channel.

This function applies only when the program is broadcast in multi-languages through the SAP broadcast system.

- 1 Press **SETUP MENU**. Then press ◀ or ▶ to select SAP.
- 2 Then press **ENTER** to select [ON].

Then press **SETUP MENU** until the menu screen is cleared.

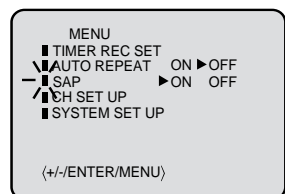

NOTES:

- When playing back a tape that is not recorded in Hi-Fi stereo mode, the audio will automatically be monaural.
- When listening to a VHS Hi-Fi video tape or MTS broadcast through the VHF/UHF jack (Audio/Video cord not connected), the sound will be monaural.

Listening to SAP

When the VCR is turned on or a channel selection is made, make certain the letters "SAP" appears on the screen. This means that the "Separate Audio Program" broadcasting is available.



OR



Duplicating a video tape/Duplicating a disc material onto a video tape

Duplicating a video tape

If you connect the VCR to another VCR or camcorder, you can duplicate a previously recorded tape. Make all connections before turning on the power.

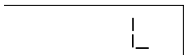
- 1 Load a blank cassette tape with the erase prevention tab intact into the recording VCR. Load a previously recorded tape into the playback VCR or CAMCORDER.
- 2 Press **SP/EP** to select the desired tape speed SP or EP. It is recommended that you set the speed to the SP mode on the recording VCR for best results.
- 3 Press **VCR CH +** or **-** to select AUDIO/VIDEO input position. "L" will appear in the .
- 4 Press **REC** on the recording VCR or on the Remote. While holding **REC**, press **PLAY**. Then press **PAUSE**.
- 5 Press **PLAY** button on the playback VCR or CAMCORDER, then press **PAUSE** button.
- 6 Press **PAUSE** on both the VCRs simultaneously to begin the duplicating process.

Connection with second Video recorder

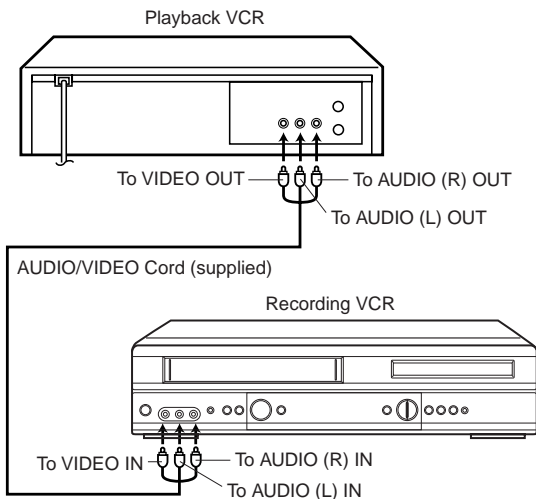

Connection with Video camera

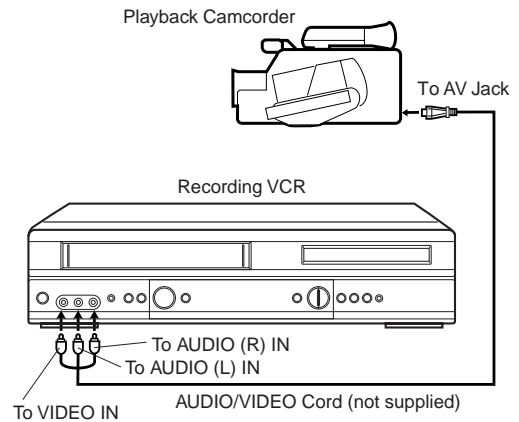

For duplicating a previously recorded tape from a camcorder, follow the camcorder manufacturer's instructions. A typical camcorder dubbing hookup is shown above.

Duplicating a disc material onto a video tape

You can record disc material in DVD, Video CD, Audio CD, etc. onto a video tape with this DVD/VCR only. If the DVD disc has a Copy-guard feature, the duplicating is not possible. A symbol mark "Ⓢ→Ⓢ" will appear on the screen for approx. 4 seconds. See page 37 for more information about the DVD playback.

Preparation:

- Load a cassette tape with the erase prevention tab intact.
- Select the tape speed in the VCR mode. (see P.28)
- Load a disc you wish to duplicate.

- 1 Press **DVD** to select the DVD mode. (The DVD indicator will light)
- 2 Press **PLAY** to start the disc playback.

- 3 During disc playback, press **REC** on the VCR or while holding **REC**, press **PLAY** on the Remote. The duplicating will start.

Note:

You can set the duplicating time using the ITR-function. At step 3 above press **REC** repeatedly until the desired duplicating time appears on the screen.(P.30)

This unit applies to DVD discs from Region 1 only.
 The loaded Disc (DVD, Video-CD, Audio-CD and MP3-CD) will be recognized automatically.
 The suitable Disc-formats are: DVD, CD-R and CD-RW.

Do not play DVD-ROM, DVD-Audio, CDV, CD-G or Photo CD to prevent accidental erasure of prerecorded material.

Some DVDs are played back with a Copy guard system. In case of a dubbing on video tape, strong disturbance may occur. This is not a defect of this DVD/VCR.

Title

When two or more movies are recorded on a disc, the disc is divided into two or more sections. Each section is called a "TITLE".

Chapter

The titles can be subdivided into many sections. Each section is called a "CHAPTER".

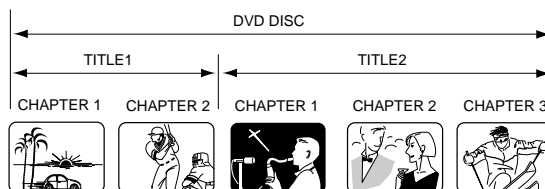

Video-CD/Audio-CD-Track

An Video CD or Audio CD can contain several items. These are assigned to the tracks.

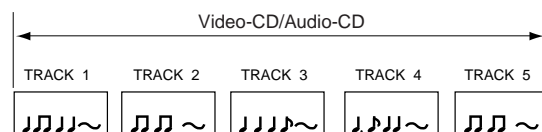

Removing Disc from Case

Be sure to hold the edge of disc. Do not touch the surface of the disc.
 Pick up the disc gently from the case.

- Do not scratch the disc.
- Do not get dirt on the surface of the disc.
- Do not stick a label or adhesive tape on the disc.
- Do not drop or bend the disc.

Storing Disc

- Store the disc in the case to avoid risk of scratches, dirt or damage.
- Do not leave disc exposed to direct sunlight or in hot or humid places.

Cleaning Disc

Wipe the disc with a clean, dry cloth from center to edge.

- Do not wipe the disc round.
- Do not use liquid or aerosol cleaners.

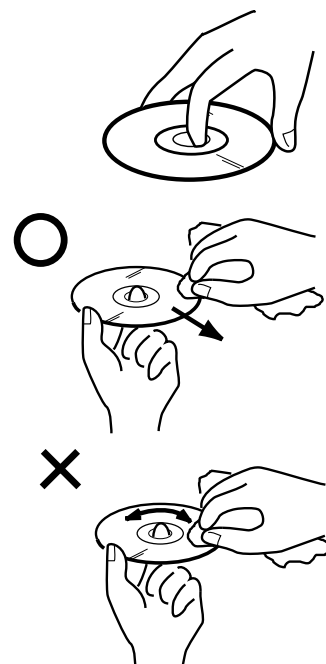

Setting setup language

The setup language can be selected.



Preparation:

- Turn ON the TV and set it to the video input mode.
- Make sure **TV/VCR/DVD** switch has been slid to VCR/DVD.
- When using an amplifier, switch on the amplifier.

- 1 Press **DVD** to select the DVD mode. (The DVD indicator will light)
“No Disc” will appear on the screen. (If a DVD disc has already loaded, the playback will start automatically.)



- 2 Press **SETUP MENU** in the stop mode. The **SETUP MENU** of DVD will appear on the screen. Then press ◀ or ▶ to select Other.

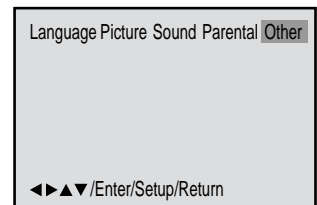

- 3 Press **ENTER** to select OSD Language.

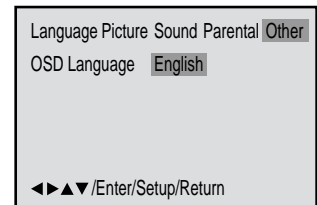

- 4 Press ▶ and then press ▲ or ▼ to select desired language (e.g. English), then press **ENTER**.

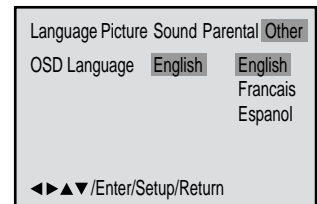

NOTE: To make the **SETUP** screen disappear, press **SETUP MENU** (or **RETURN**).

If the DVD/VCR does not operate properly: Static electricity, etc., may affect the player's operation. Disconnect the AC power cord once, then connect it again.

Playback procedure



Preparation:

- Turn ON the TV and set it to the video input mode.
- Make sure **TV/VCR/DVD** switch has been slid to VCR/DVD. Then press **DVD** to select the DVD mode. (The DVD indicator will light.)

- 1 Press **OPEN/CLOSE**.
The disc tray will open.



- 2 Place a disc onto the tray.
Hold the disc, position it with the printed label side up, align it with the guides, and place it in its proper position.

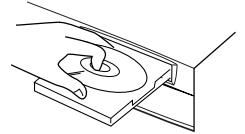

- 3 Press **PLAY** or **OPEN/CLOSE**.
The disc tray closes automatically.
On the screen, ▲ changes to "Reading" and then playback will commence.



- A menu screen may appear on the TV screen, if the disc has a menu feature. In this case, press ▲, ▼, ◀, ▶ or **ENTER** to operate a menu feature.

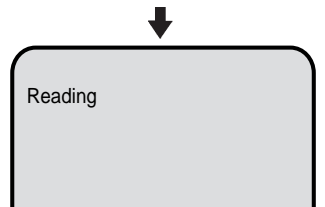

- 4 Press **STOP** to end playback.
 - The DVD/VCR memorizes the stopped point, depending on the disc. "■" appears on the screen for approx. 4 seconds. "▶" keep blinking in the display until the playback is stopped completely. Press **PLAY** to resume playback (from the scene point).
 - If you press **STOP** again ("■" appears on the screen) or unload the disc, the DVD/VCR will clear the stopped point.

- 5 Then press **OPEN/CLOSE**.
The disc tray opens.
Remove the disc and press **POWER**.
The disc tray closes automatically and DVD/VCR turns off.

Notes:

- If a non-compatible disc is loaded, "Incorrect Disc", "Region Code Error" or "Parental Error" will appear on the TV screen according to the type of loaded disc. In this case, check your disc again (See pages 35 and 46).
- Some discs may take a minute or so to start playback.
- A "Prohibition" symbol (hand with slash) may appear at the upper left of the screen. This symbol means either the feature you tried is not available on the disc, or the DVD/VCR can not access the feature at this time. This does not indicate a problem with the DVD/VCR.
- When you set a single-faced disc label downwards (ie. the wrong way up) and press **PLAY** or **OPEN/CLOSE**, "Reading" will appear and remain on the screen for approx. 40 seconds and then it will change to "Incorrect Disc".
- Some playback operations of DVDs may be intentionally fixed by software producers. Since this DVD/VCR plays DVDs according to the disc contents the software producers designed, some playback features may not be available. Also refer to the instructions supplied with the DVDs.
- When playing DTS-encoded Audio CDs, excessive noise will be heard from the analog stereo outputs. To avoid possible damage to the audio system, the consumer should take proper precautions when the analog stereo outputs of the DVD/VCR are connected to an amplification system.

Special playback

Note: There may be a slight delay between pressing the button and the function activation.



Note:

The unit is capable of holding a still video image or On screen display image on your television screen indefinitely. If you leave the still video image or On screen display image displayed on your TV for an extended period of time, you risk permanent damage to your television screen. Projection televisions are very susceptible.

Fast Forward Playback

Press **FF** during normal playback.

Each press of **FF** will increase the speed of the search ►► (x2), ►►►► (x4), ►►►►►► (x8), ►►►►►►►► (x20).

- To resume normal playback, press **PLAY**.

Review Playback

Press **REW** during normal playback.

Each press of **REW** will increase the speed of the search ◀◀ (x2), ◀◀◀◀ (x4), ◀◀◀◀◀◀ (x8), ◀◀◀◀◀◀◀◀ (x20).

- To resume normal playback, press **PLAY**.

Still Playback

Press **PAUSE** during normal playback.

To resume normal playback, press **PLAY**.



Frame Advance

Press **PAUSE** during still playback. One frame is advanced each time you press **PAUSE**.

To resume normal playback, press **PLAY**.



Slow-motion Playback

Press **SLOW** during normal playback or still playback.

Each press of **SLOW** will change the speed of the slow x1/2, x1/4, x1/6, x1/7.

- To resume normal playback, press **PLAY**.
- To resume the still playback, press **PAUSE**.

Locating a chapter or track

Press **SKIP (►►)** Forward or **SKIP (◀◀)** Reverse during playback to locate a chapter that you want to watch.

Each time you press the button, a chapter or track is skipped.

Zooming / Locating Desired Scene



Notes:

- You can use the Pause, Slow, Search or Skip feature in the zoom mode.
- In case of the Video-CD playback with PBC, the SEARCH MODE does not work.

Preparation:

- Turn ON the TV and set it to the video input mode.
- Make sure **TV/VCR/DVD** switch has been slid to VCR/DVD. Then press **DVD** to select the DVD mode. (The DVD indicator will light.)

Zooming

This unit will allow you to zoom in on the frame image. You can then make selections by switching the position of the frame.

- 1 Press **ZOOM** during playback. The center part of the image will be zoomed in. Each press of **ZOOM** will change the ZOOM Q_1 (x 1.3), Q_2 (x 1.5) and Q_3 (x 2.0).
- 2 Press $\blacktriangle/\blacktriangledown$ or $\blacktriangleleft/\blacktriangleright$ to view a different part of the frame. You may move the frame from the center position to UP, DOWN, LEFT or RIGHT direction.
- 3 In the zoom mode press **ZOOM** repeatedly to return to a 1:1 view (Q Off).

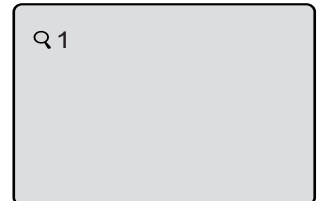

Locating Desired Scene

Use the title, chapter and time recorded on the disc to locate the desired point to play back.

To check the title, chapter and time, press **OSD**. (see page 52)

- 1 Press **SEARCH MODE** during playback or stop mode.

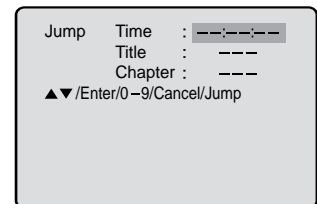

- 2 Press \blacktriangle or \blacktriangledown to select the "Time", "Title" or "Chapter".
- 3 Press **Number keys** to change the number.

- If you input a wrong number, press **CANCEL**.
- Refer to the package supplied with the disc to check the numbers.

- 4 Press **ENTER**. Playback starts.

- When you change the title, playback starts from Chapter 1 of the selected title.
- Some discs may not work in the above operation.

Repeat playback



Notes:

- Some discs may not work with the repeat operation.
- In A-B repeat mode, subtitles near point A or B may not appear.
- During the A-B Repeat Playback the ANGLE feature will not operate.
- You may not be able to set A-B Repeat, depending on the scenes of the DVD.
- A-B repeat does not work with an interactive DVD, MP3-CD and Video-CD with PBC.

Preparation:

- Turn ON the TV and set it to the video input mode.
- Make sure **TV/VCR/DVD** switch has been slid to VCR/DVD. Then press **DVD** to select the DVD mode. (The DVD indicator will light.)

Title, Chapter, Track Playback

- 1 Press **PLAY MODE** during playback or stop mode.

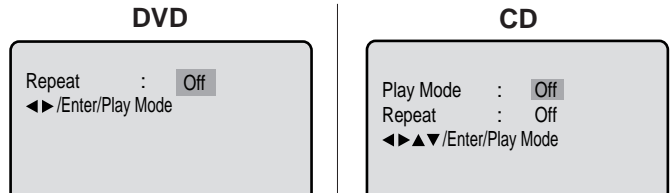

- 2 Press **ENTER** once or twice to select "Chapter" or "Title".
In case of CD, at first press ▼ to select "Repeat" and then press **ENTER** once or twice to select "Track" or "All".

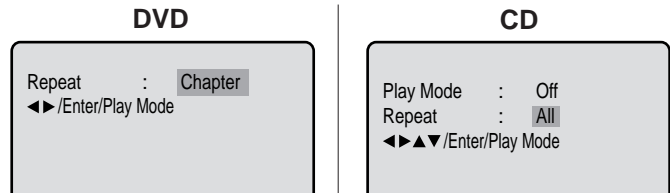

- 3 Press **PLAY MODE** again to make the screen disappear.

- Press **PLAY** to start Repeat playback.
- To resume normal playback, select Repeat Off.

A-B Repeat Playback

A-B repeat playback allows you to repeat material between two selected points.

- 1 Press **REPEAT A-B** during playback.
The start point is selected.

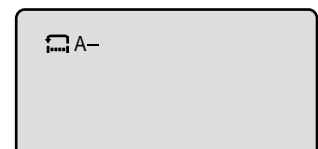

- 2 Press **REPEAT A-B** again.
The end point is selected. Playback starts at the point that you selected. Playback stops at the end point, returns to Point A automatically, then starts again.

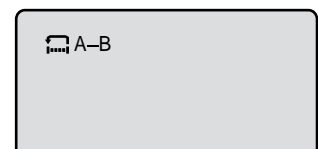

To resume normal playback press **REPEAT A-B** again.
"Off" appears on the screen.

Program playback/Random playback (CD)



Preparation:

- Turn ON the TV and set it to the video input mode.
- Make sure **TV/VCR/DVD** switch has been slid to VCR/DVD. Then press **DVD** to select the DVD mode. (The DVD indicator will light.)

Program playback

You can arrange the order of tracks on the disc.

- 1 Press **PLAY MODE** in the stop mode.

```
Play Mode : Off
Repeat : Off
◀▶▲▼/Enter/Play Mode
```

- 2 Press **ENTER** repeatedly until the Program table as right appears.

```
Play Mode : Program
Repeat : Off
1 --- 4 --- 7 --- 10 ---
2 --- 5 --- 8 --- 11 ---
3 --- 6 --- 9 --- 12 ---
Clear Program Playback
◀▶▲▼/Enter/0-9/Cancel/Play Mode
```

- 3 **Example:** In case you wish to program in order of 7, 3, 11: Enter as 7 ▼, 3 ▼, 11.

If you input a wrong number, press **CANCEL**.

```
Play Mode : Program
Repeat : Off
1 7-- 4 --- 7 --- 10 ---
2 3-- 5 --- 8 --- 11 ---
3 11- 6 --- 9 --- 12 ---
Clear Program Playback
◀▶▲▼/Enter/0-9/Cancel/Play Mode
```

- 4 Press ▲/▼ or ◀/▶ to select "Program Playback" and press **ENTER**. "Program Playback" will appear on the screen. The program you selected will begin to playback in the order set. To return to normal playback, select "Play Mode: Off" at step 2 above.

```
Program Playback
```

Random playback

- 1 Press **PLAY MODE** in the stop mode.

```
Play Mode : Off
Repeat : Off
◀▶▲▼/Enter/Play Mode
```

- 2 Press ◀/▶ to select "Random".

```
Play Mode : Random
Repeat : Off
◀▶▲▼/Enter/Play Mode
```

- 3 Press **PLAY**. "Random Play" will appear on the screen and Random Playback will start.

Notes:

- To cancel program play, select "Clear" at step 3 and press **ENTER**.
- The program is cancelled when you open the disc tray or turn the power off.
- Random playback can not be combined with Repeat playback.

MP3 Playback

This player can play back the MP3-data which has been recorded on CD-R or CD-RW. To produce the MP3-data, you need a Windows-PC with CD-ROM drive and a MP3-encoding Software (not supplied). The Apple-HFS-System can not be played.

MP3 CD Information

Limitations on MP3 CD playback

- MP3 CD is the disc that is standardized by ISO9660, its file name must include 3-digits extension letters, "mp3".
- The directory and file names of the MP3 CD must be correspond to the ISO standardized files.
- This unit can read 200 files per disc. If one directory has more than 200 files, it reads up to 200 files, the remaining files will be omitted.
- As for multi-session disc, only the first session can be played.
- If the CD has both audio tracks and MP3 files, only audio tracks are played.
- It may take more than one minute for this unit to read MP3 files depending on its structure.
- Music recorded by "Joliet Recording Specification" can be played back, the file name is displayed (within 17 letters) on the screen Long file names will be condensed.
- The music files recorded by "Hierarchical File System" (HFS) cannot be played.

Limitations on display

- The maximum number for display is 17 letters. Available letters for display are the following: capital or small alphabets of A through Z, numbers of 0 through 9, and _ (under score).
- Other letters than those above are replaced in hyphen.

Notes on MP3 files

- To play back MP3 CD in the recorded order,
1. Use MP3 software that records data alphabetically or numerically.
 2. Name each file including two-digit or three-digit number (e.g. "01" "02" or "001" "002").
 3. Refrain from making too many sub-folders.

CAUTION:

- Some MP3 CDs can not be played back depending on the recording conditions.
- The CD-R/RW that has no music data or non-MP3 files can not be played back.

Preparation:

- Turn ON the TV and set it to the video input mode.
- Make sure **TV/VCR/DVD** switch has been slid to VCR/DVD. Then press **DVD** to select the DVD mode. (The DVD indicator will light.)

- 1 Press **OPEN/CLOSE**.
The disc tray will open.
Place a disc onto the tray.

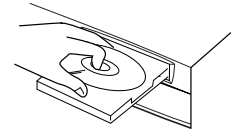

- 2 Press **PLAY** or **OPEN/CLOSE**.
The disc tray closes automatically.
On the TV-screen, "Reading" and then reading file number will appear. Reading will take as much time as the number of file.

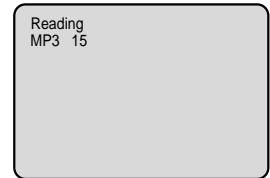

- 3 A MP3 menu screen will appear on the TV screen.
Press **◀/▶** or **ENTER** to select folder.

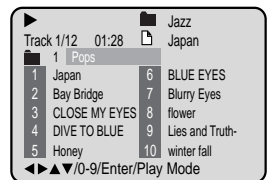

- 4 Press **▲/▼** or **◀/▶** or **Number keys** to select the desired track, then press **ENTER**. Track is selected and play commences.
 - In case the folder includes more than 11 tracks, press **◀** or **▶** to display next track list.

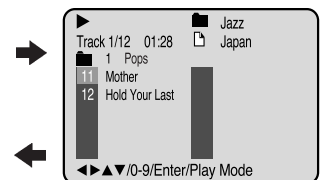
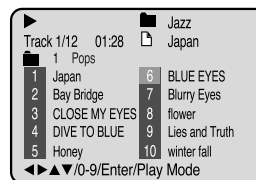

- 5 Press **STOP** to end playback.
 - The unit records the stopped point. "■" appears on the screen. Press **PLAY** to resume playback (from the scene point).
 - If you press **STOP** again or unload the disc, the unit will clear the stopped point.

- 6 Then press **OPEN/CLOSE**.
The disc tray opens.
Remove the disc and press **POWER**.
The disc tray closes automatically and DVD/VCR turns off.

Notes:

- During MP3-Playback, you can not use **SEARCH**, **A-B Repeat** functions.
- You can use **Repeat** (Track or All), **Random** functions and **Program playback** for MP3 CD Playback. (See page 40 and 41)

Marking Desired Scenes

The unit stores the points that you want to watch again up to 3 points. You can resume playback from each scene.



Notes:

- Some discs may not work with the marking operation.
- The marking is canceled when you open the disc tray or turn the power off.
- Some subtitles recorded around the marker may fail to appear.
- While the MARKER screen is displayed, if you do a special playback as the Fast Forward/Review Playback or SKIP, the MARKER screen will disappear. Press **MARKER** again as soon as you find the desired scene.

Preparation:

- Turn ON the TV and set it to the video input mode.
- Make sure **TV/VCR/DVD** switch has been slid to VCR/DVD. Then press **DVD** to select the DVD mode. (The DVD indicator will light.)

Marking the Scenes

- 1 Press **MARKER** during playback.

```
Marker 1 : **: **: **
Marker 2 : **: **: **
Marker 3 : **: **: **
▲▼/Enter/Cancel/Marker
```

- 2 Select the blank Marker using ▲/▼. Then press **ENTER** at the desired scene.

```
Marker 1 : 00 : 27 : 54
Marker 2 : **: **: **
Marker 3 : **: **: **
▲▼/Enter/Cancel/Marker
```

- Repeat this procedure to set the other 2 scenes.

- 3 Press **MARKER** to remove this display.

Returning to the Scenes

- 1 Press **MARKER** during playback or stop mode.

```
Marker 1 : 00 : 27 : 54
Marker 2 : 01 : 16 : 25
Marker 3 : 02 : 08 : 31
▲▼/Enter/Cancel/Marker
```

- 2 Press ▲/▼ to select the Marker 1-3.

```
Marker 1 : 00 : 27 : 54
Marker 2 : 01 : 16 : 25
Marker 3 : 02 : 08 : 31
▲▼/Enter/Cancel/Marker
```

- 3 Press **ENTER**. Playback starts from the marked scene.

To Cancel the Mark

- 1 Press **MARKER**.
- 2 Press ▲/▼ to select the Marker 1-3.
- 3 Press **CANCEL**. To remove this display, press **MARKER**.

Changing soundtrack language / Subtitles

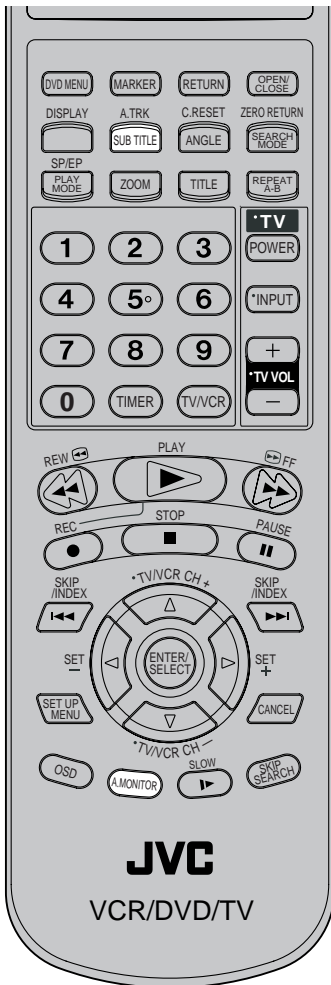

Preparation:

- Turn ON the TV and set it to the video input mode.
- Make sure **TV/VCR/DVD** switch has been slid to VCR/DVD. Then press **DVD** to select the DVD mode. (The DVD indicator will light.)

Changing soundtrack language

You can select the language when you play a multilingual disc.

- 1 Press **A.MONITOR** during playback. The current soundtrack language will appear.



- 2 Press **A.MONITOR** repeatedly until the desired language is selected. The on-screen display will disappear after a few seconds.

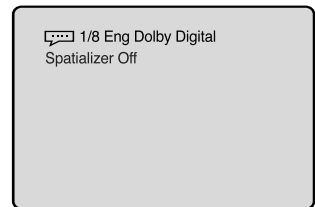

In case of VIDEO CD playback

Audio type changes as follows each time you press **A.MONITOR**.

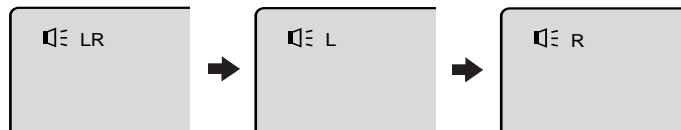

Turning the Subtitles On and Off

When playing back a disc recorded with subtitles, you can turn the subtitles on or off.

Press **SUB TITLE** during playback until "OFF" appears.



Changing the subtitle language

You can select the language when playing back a disc recorded with multi-lingual subtitles.

Press **SUB TITLE** repeatedly during playback until your desired language appears.

The on-screen display will disappear after a few seconds.

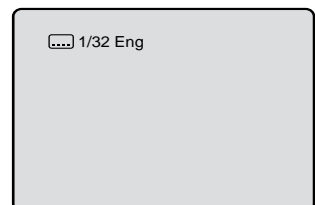

Notes:

- If the desired language is not heard after pressing the button several times, the language is not recorded on the disc.
- Changing soundtrack or subtitle language is cancelled when you open the disc tray or turn the power off. The initial default language or available language will be heard and seen if the disc is played back again.
- Depending on the DVD you may be unable to turn on, turn off, or change the subtitles, even if they are recorded on the disc. While playing the DVD, the subtitle may change while opening or closing the disc tray, or while changing the title.
- In some cases, the subtitle language is not changed to the selected one immediately.

Changing angles / Title selection / DVD menu



Note:

Depending on the DVD, you may not be able to change the angles even if multi-angles are recorded on the disc, or you may be unable to select the title, and a "title menu" may simply be called a "menu" or "title" in the instructions supplied with the disc.

Preparation:

- Turn ON the TV and set it to the video input mode.
- Make sure **TV/VCR/DVD** switch has been slid to VCR/DVD. Then press **DVD** to select the DVD mode. (The DVD indicator will light.)

Changing Angles

When playing back a disc recorded with multi-angle facility, you can change the angle that you are viewing the scene from.

- 1 Press **ANGLE** during playback.
The current angle will appear.

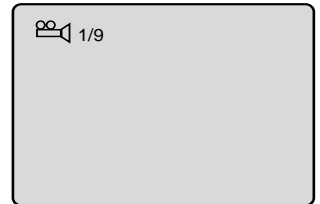

- 2 Press **ANGLE** repeatedly until the desired angle is selected.

Title Selection

Two or more titles are recorded on some discs. If the title menu is recorded on the disc, you can select the desired title.

- 1 Press **TITLE** during playback.
Title menu appears on the screen.
 - Press **TITLE** again to resume playback at the scene when you pressed **TITLE**.
- 2 Press **▲/▼** or **◀/▶** to select the desired title.
- 3 Press **ENTER** or **PLAY**.
The playback of the selected title will start.

DVD Menu

Some DVDs allow you to select the disc contents using the menu.

When you play back these DVDs, you can select the subtitle language and sound-track language, etc. using the DVD menu.

- 1 Press **DVD MENU** during playback.
The DVD menu appears on the screen.
 - Press **DVD MENU** again to resume playback at the scene when you pressed **DVD MENU**.
- 2 Press **▲/▼** or **◀/▶** to select the desired item.
- 3 Press **ENTER**.
The menu continues to another screen. Repeat steps 2 and 3 to set the item completely.

Parental control

Some discs are specified not suitable for children. Such discs can be prevented from play back with the unit.



Notes:

- If each setup (page 46~52) has been completed, the unit can always be worked under the same conditions (especially with DVD discs). Each setup will be retained in the memory if you turn the power off.
- Depending on the discs, the unit cannot limit playback.
- Some discs may not be encoded with specific rating level information though its disc jacket says "adult". For those discs, the age restriction will not work.
- Do not forget the password. If you forget the password, contact customer service.

Preparation:

- Turn ON the TV and set to the video input mode.
- Make sure **TV/VCR/DVD** switch has been slid to VCR/DVD. Then press **DVD** to select the DVD mode. (The DVD indicator will light.)

Parental control setting

- 1 Press **SETUP MENU** in the stop mode. Press ◀ or ▶ to select "Parental". Then press **ENTER**.

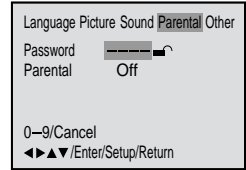

- 2 Press ▲ or ▼ to select "Parental Off", then press **ENTER** until the level you desire appears (e.g.: 1).

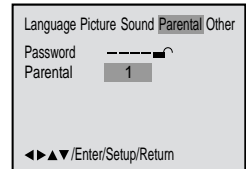

- 3 Press ▲ once to select "Password ----". Then press **Number keys** to input a 4-digit password (e.g.: 1234).

- If you input a wrong number, press **CANCEL**.
- Be sure to remember this number!

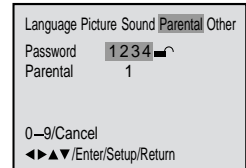

- Level Off** : The parental control setting does not function.
- Level 1** : DVD software for adults cannot be played back.
- Level 8** : All DVD software can be played back.

Select from level 1 to level 8.
On a scale of 1-8, "1" is the most restrictive.

- 4 Press **ENTER**.

1234 change to ----.

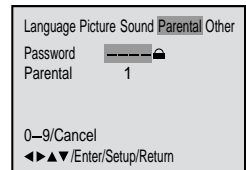

- 5 To make SETUP screen disappear, press **SETUP MENU**.

To unlock the Parental Control Setting

Cancel the password so as to set the Parental level freely again,

- 1 Select "Password ----" (step 1) and press **Number keys** to input your 4-digit password. Then press **ENTER**.

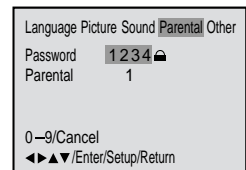

- 2 If the input password was right, ---- will appear. You can move to "Parental 1"(e.g.) to input the desired level or to cancel parental control.

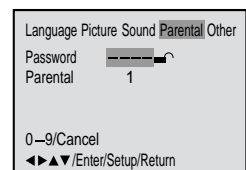

Temporary disabling of rating level by DVD disc

Depending on the DVD disc, the disc may try to temporarily cancel the rating level that you have set. It is up to you to decide whether to cancel the rating level or not.



Preparation:

- Turn ON the TV and set to the video input mode.
- Make sure **TV/VCR/DVD** switch has been slid to VCR/DVD. Then press **DVD** to select the DVD mode. (The DVD indicator will light.)

- 1 Load a DVD disc and press **PLAY** or **OPEN/CLOSE** (see page 37).

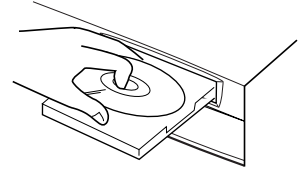

- 2 If the DVD disc has been designed to temporarily cancel the Rating level, the screen which follows the "Reading" screen will change, depending on which disc is played. If you select "YES" with **ENTER** key, "Your disc exceeds the parental control level 1." (e.g.) screen will then appear.



Your disc exceeds the parental control level 1.

Parental Control Level
Cancel Picture
▲▼/Enter/Return

- 3 If you wish to cancel the set rating level temporarily, select "Parental Control Level" with **▲** or **▼**, then press **ENTER**. If the 4-digits password at step 3 on page 46 has been set, the password entering screen will appear as shown in step 4 below. Alternatively, if the password has not been set, playback will commence. If you don't know (or have forgotten) the password, select "Cancel Picture". The setting screen will disappear. Press **OPEN/CLOSE** to remove the disc.

- 4 Enter the password with **Number buttons (0-9)**. Then press **ENTER**.

Please enter the 4 - digit password

Enter/0 - 9/Cancel/Return

If you interrupt the entering, press **RETURN**.

- 5 Playback will commence if the entered password was correct.

Note:

This temporary cancellation of rating level will be kept until the disc is ejected. When the disc is ejected, the original rating level will be set again automatically.

Setting menu language

You can select the language of the disc menu messages of DVDs.



Preparation:

- Turn ON the TV and set to the video input mode.
- Make sure **TV/VCR/DVD** switch has been slid to VCR/DVD. Then press **DVD** to select the DVD mode. (The DVD indicator will light.)

- 1 Press **SETUP MENU** in the stop mode.
Press ◀ or ▶ to select "Language".

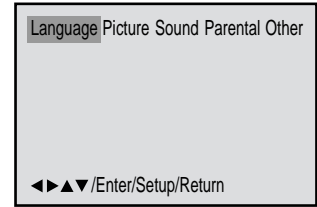

- 2 Press **ENTER**.
Then press ▲ or ▼ to select "Menu".

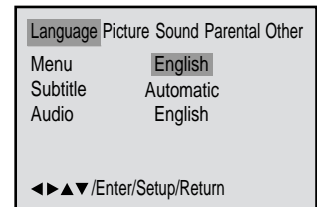

- 3 Press **ENTER**.
Press ▲ or ▼ to select your desired language, then press **ENTER**.

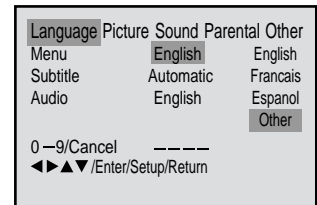

English, Francais, Espanol

The selected language is the first-priority Menu language.

OTHER: Other language can be selected (See the Language Code List on page 54).

- 4 To make SETUP screen disappear, press **SETUP MENU**.

Setting subtitle language

The same subtitle language can always be selected even if you replace the disc or turn the power off.



Note:

If the selected language is not recorded on the disc, the first-priority language is selected.

Preparation:

- Turn ON the TV and set to the video input mode.
- Make sure **TV/VCR/DVD** switch has been slid to VCR/DVD. Then press **DVD** to select the DVD mode. (The DVD indicator will light.)

- 1 Press **SETUP MENU** in the stop mode.
Press ◀ or ▶ to select "Language"

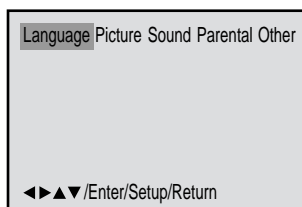

- 2 Press **ENTER**.
Then press ▲ or ▼ to select "Subtitle".

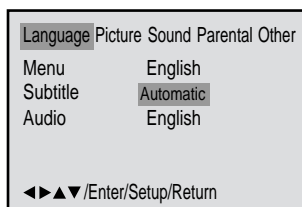

- 3 Press **ENTER**.
Press ▲ or ▼ to select your desired language, then press **ENTER**.

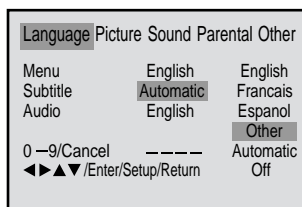

English, Francais, Espanol

The subtitle is displayed with the selected language if it is recorded on the disc.

OTHER:

If you want to select another language, enter the language code (see the language code list on page 54).

AUTOMATIC:

- The unit will automatically select the same language in the AUDIO setting.
- When the unit selects the same language as the AUDIO, the subtitles will not appear during playback.
- When you do not use the same language as the AUDIO, the subtitles will appear during playback.

Off:

Subtitles do not appear.

- 4 To make SETUP screen disappear, press **SETUP MENU**.

Setting audio soundtrack language / Setting surround sound

Setting audio soundtrack language

The same audio soundtrack language can always be selected by your unit even if you replace the disc or turn the power off.

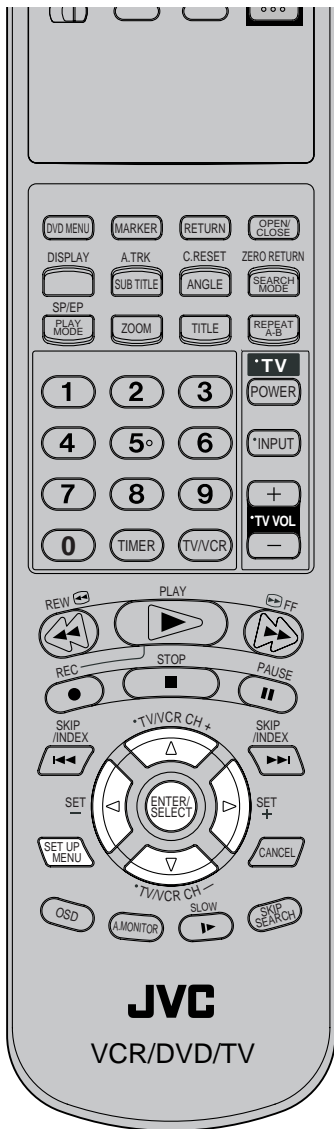

Notes:

- If the selected language is not recorded on the disc, the original language will be heard.
- The "SPATIALIZER N-2-2" is effective only for the sound of disc.

To cancel Surround mode:

Follow the right steps 1~2, then press **ENTER** to select the [Off] position.

Preparation:

- Turn ON the TV and set to the video input mode.
- Make sure **TV/VCR/DVD** switch has been slid to VCR/DVD. Then press **DVD** to select the DVD mode. (The DVD indicator will light.)

- 1 Press **SETUP MENU** in the stop mode.
Press ◀ or ▶ to select "Language"

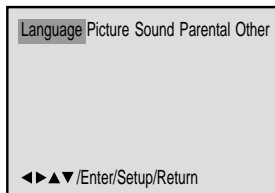

- 2 Press **ENTER**.
Then press ▲ or ▼ to select "Audio".

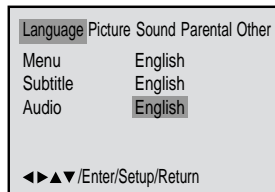

- 3 Press **ENTER**.
Press ▲ or ▼ to select your desired Audio Language, then press **ENTER**.

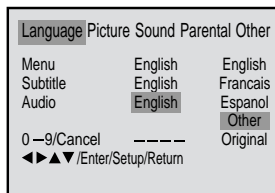

- **English, Francais, Espanol:**
The language you have selected will play if it is recorded on the disc.
- **OTHER:** If you want to select another language, enter the language code (See the Language Code List on page 54).
- **ORIGINAL:** The unit will select the first priority language of each disc.

- 4 To make SETUP screen disappear, press **SETUP MENU**.

Setting surround sound

This DVD/VCR equipped with a "SPATIALIZER N-2-2". It can produce the effect of being in a cinema or a concert hall.

- 1 During disc playback press **A. MONITOR**.
- 2 Press ▶ to select [On].

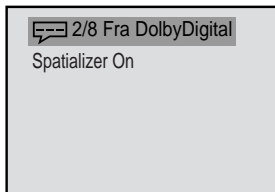

Setting the aspect ratio of TV screen

You can select the aspect ratio for your TV.



Preparation:

- Turn ON the TV and set to the video input mode.
- Make sure **TV/VCR/DVD** switch has been slid to VCR/DVD. Then press **DVD** to select the DVD mode. (The DVD indicator will light.)

- 1 Press **SETUP MENU** in the stop mode.
Press ◀ or ▶ to select "Picture".

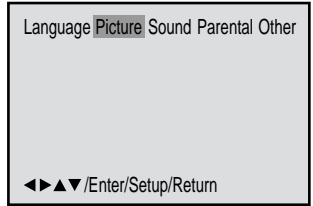

- 2 Press **ENTER**, then press ▲ or ▼ to select "Tv Screen".

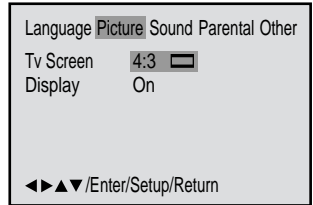

- 3 Press **ENTER**.
Press ▲ or ▼ to select your desired screen type, then press **ENTER**.

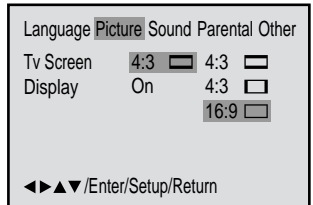

You have the following screen sizes to choose from:

4:3 NORMAL TV

Select this mode when connecting to a conventional TV. When playing back a wide screen-DVD disc, it displays the wide picture with black bands at the top and bottom of screen.

4:3 PAN SCAN

It displays the wide picture on the whole screen with left and right edges automatically cut off.

16:9 WIDE SCREEN

Select this mode when connecting to a wide-screen TV. A wide screen picture is displayed full size.

- 4 To make SETUP screen disappear, press **SETUP MENU**.

Note:

If the DVD disc is not formatted in the pan & scan style, it displays 4:3 style.

Setting on Screen display / Status display of Disc

On screen display can be switched on or off when you press the buttons.



Preparation:

- Turn ON the TV and set to the video input mode.
- Make sure **TV/VCR/DVD** switch has been slid to VCR/DVD. Then press **DVD** to select the DVD mode. (The DVD indicator will light.)

1 Press **SETUP MENU** in the stop mode.

Press ◀ or ▶ to select "Picture"

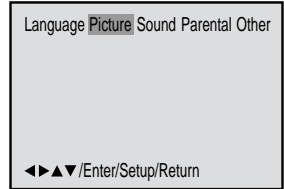

2 Press **ENTER**, then press ▲ or ▼ to select "Display".

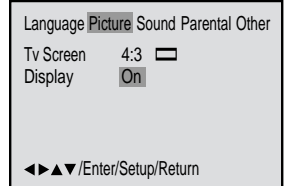

3 Press **ENTER** to select "On" or "Off".

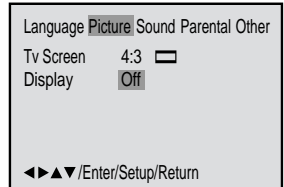

On: On screen displays appears when you press the any buttons (factory setting).

Off: On screen displays do not appear when you press any buttons except **SETUP MENU**, **SEARCH MODE**, **PLAY MODE**, **MARKER** and **OSD**.

4 To make SETUP screen disappear, press **SETUP MENU**.

Status display of Disc

Each press of **OSD**, the status display of the disc will appear on the screen and change as follows.

DVD

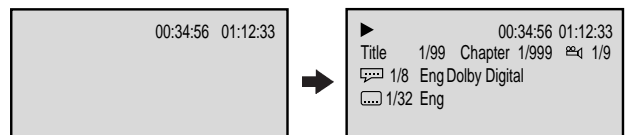

To make status display disappear, press **OSD** again.

VIDEO CD

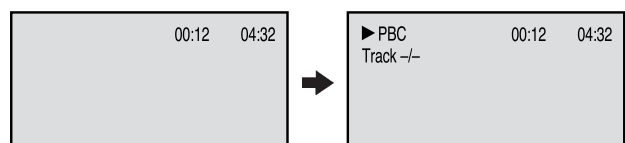

AUDIO CD

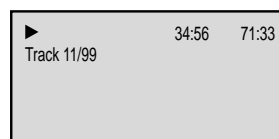

When you playback the CD disc, the status display will appear on the screen and continue displaying.

Dynamic Range Control

DRC (Dynamic Range Control) enables you to control the dynamic range so as to achieve a suitable sound for your equipment.



Notes:

- This function works only during playback of Dolby Digital recorded discs.
- The level of Dynamic Range Reduction may differ depending on DVD video disc.

Preparation:

- Turn ON the TV and set to the video input mode.
- Make sure **TV/VCR/DVD** switch has been slid to VCR/DVD. Then press **DVD** to select the DVD mode. (The DVD indicator will light.)

- 1 Press **SETUP MENU** in the stop mode. Press **◀** or **▶** to select "Sound".

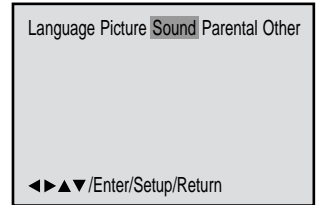

- 2 Press **▼** or **ENTER** to select "DRC".

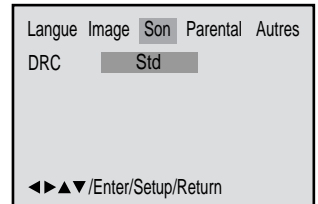

- 3 Press **▶** or **ENTER**, then press **▲** or **▼** to select desired setting.

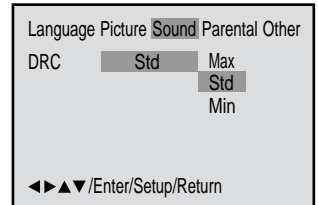

- Max:** Full dynamic range is increased.
- Std:** Full dynamic range is maintained.
- Min:** Dynamic range is reduced.

Language Code List

Enter the appropriate code number for the initial settings "Audio", "Subtitle" and/or "Menu" (see pages 48-50).

Language Name	Code	Language Name	Code	Language Name	Code	Language Name	Code
Abkhazian	1112	Fiji	1620	Lingala	2224	Sinhalese	2919
Afar	1111	Finnish	1619	Lithuanian	2230	Slovak	2921
Afrikaans	1116	French	1628	Macedonian	2321	Slovenian	2922
Albanian	2927	Frisian	1635	Malagasy	2317	Somali	2925
Amharic	1123	Galician	1722	Malay	2329	Spanish	1529
Arabic	1128	Georgian	2111	Malayalam	2322	Sundanese	2931
Armenian	1835	German	1415	Maltese	2330	Swahili	2933
Assamese	1129	Greek	1522	Maori	2319	Swedish	2932
Aymara	1135	Greenlandic	2122	Marathi	2328	Tagalog	3022
Azerbaijani	1136	Guarani	1724	Moldavian	2325	Tajik	3017
Bashkir	1211	Gujarati	1731	Mongolian	2324	Tamil	3011
Basque	1531	Hausa	1811	Nauru	2411	Tatar	3030
Bengali; Bangla	1224	Hebrew	1933	Nepali	2415	Telugu	3015
Bhutani	1436	Hindi	1819	Norwegian	2425	Thai	3018
Bihari	1218	Hungarian	1831	Oriya	2528	Tibetan	1225
Breton	1228	Icelandic	1929	Panjabi	2611	Tigrinya	3019
Bulgarian	1217	Indonesian	1924	Pashto, Pushto	2629	Tonga	3025
Burmese	2335	Interlingua	1911	Persian	1611	Turkish	3028
Byelorussian	1215	Irish	1711	Polish	2622	Turkmen	3021
Cambodian	2123	Italian	1930	Portuguese	2630	Twi	3033
Catalan	1311	Japanese	2011	Quechua	2731	Ukrainian	3121
Chinese	3618	Javanese	2033	Rhaeto-Romance	2823	Urdu	3128
Corsican	1325	Kannada	2124	Romanian	2825	Uzbek	3136
Croatian	1828	Kashmiri	2129	Russian	2831	Vietnamese	3219
Czech	1329	Kazakh	2121	Samoan	2923	Volapük	3225
Danish	1411	Kirghiz	2135	Sanskrit	2911	Welsh	1335
Dutch	2422	Korean	2125	Scots Gaelic	1714	Wolof	3325
English	1524	Kurdish	2131	Serbian	2928	Xhosa	3418
Esperanto	1525	Laothian	2225	Serbo-Croatian	2918	Yiddish	2019
Estonian	1530	Latin	2211	Shona	2924	Yoruba	3525
Faroese	1625	Latvian, Lettish	2232	Sindhi	2914	Zulu	3631

Problems and troubleshooting

Use the following check list for troubleshooting when you have problems with your unit. Consult your local dealer or service outlet if problems persist.

Be sure all connections are properly made when using with other units.

SYMPTOMS	POSSIBLE SOLUTIONS	PAGE
DVD/VCR		
DVD/VCR does not operate.	<ul style="list-style-type: none"> • Make sure the power cord is plugged in. • Try another AC outlet. • Power is off, check fuse or circuit breaker. • Unplug unit, then plug it back in. • Select the DVD or VCR mode before operating. • Make sure TV/VCR/DVD switch has been slid to VCR/DVD. 	5 – – 5 18,36 18,36
No picture.	<ul style="list-style-type: none"> • Antenna connection is not correct or antenna cable is disconnected. • The video channel is not in the correct position or the TV is not set to the video channel 3 or 4. • Check the unit is connected correctly. • The video input selector of the TV is not set to VIDEO. Set to VIDEO (or equivalent). • Channel is set to the external mode. 	12~15 18 12~17 – –
No sound.	<ul style="list-style-type: none"> • Check the unit is connected correctly. • Check the input selector of the amplifier is set properly. • The unit is in the Special playback mode. 	12~17 – 26,38
The remote control does not function.	<ul style="list-style-type: none"> • Aim the remote control at the remote sensor. • Operate within Approx. 5 Meters or reduce the light in the room. • Clear the path of the beam. • The batteries are weak. Replace the batteries. • Check the batteries are inserted correctly. • Check the frequency code is set correctly. 	11
The DVD-keys on the RCU of the other JVC RECEIVER/TV is not effective.	<ul style="list-style-type: none"> • This is not a defect. Since this unit is combined type of DVD and VCR, the remote code of DVD is individual. 	10
No CATV reception	<ul style="list-style-type: none"> • Check all CATV connections. • Station or CATV system problems, try another station. 	14,15
No POWER but a picture appears on the TV screen.	<ul style="list-style-type: none"> • During the Auto Clock operation, a video signal can be put out. Please set the clock with Manual clock setting or wait until the Auto Clock operation completed. 	23
VCR		
TV recording does not work.	<ul style="list-style-type: none"> • The erase prevention tab of the video cassette is broken off. • The unit is in the external input mode. 	24,28
Timer recording does not work.	<ul style="list-style-type: none"> • The time is not set correctly. • The recording start/end time is not set correctly. • The TIMER has not been pressed (□ is not lit). 	21,23 31 31
Noise bars on screen.	<ul style="list-style-type: none"> • Tracking adjustment beyond range of automatic tracking circuit. Try Manual tracking adjustment. • Video heads are dirty. • The tape is worn or damaged. 	26 56 –
DVD		
Display is not shown in your language.	<ul style="list-style-type: none"> • Select proper language in the menu options. 	36
Playback doesn't start.	<ul style="list-style-type: none"> • No disc is inserted. • The disc may be dirty. Clean up the disc. • The unit cannot play DVD-ROMs, etc. 	37 35 35

Problems and troubleshooting / Video head cleaning

SYMPTOMS	POSSIBLE SOLUTIONS	PAGE
Stopping playback, search, slow-motion play, repeat play, or program play, etc. cannot be performed.	• Some discs may not do some of the functions.	–
No 4:3 (16:9) picture	• The setup does not match your TV.	51
No on-screen display	• Select Display On.	52
No surround sound	• The setup does not match your stereo system.	17
The unit or remote operation key is not functioning.	• Turn off the unit and unplug the AC power cord for several minutes, then replug it.	–
Playback does not start when the title is selected.	• Check the Parental setup.	46
Audio soundtrack and/or subtitle language is not changed when you play back a DVD.	• Multilingual language is not recorded on the DVD disc.	49,50
No subtitle	• Some discs have no subtitles. • Subtitles are cleared. Press SUB TITLE.	49
Angle cannot be changed.	• Multi-angles are not recorded on the DVD disc.	45
✎ appears on the screen.	• The function is prohibited with the unit or the disc.	–

Video head cleaning

Video head clogging

The video heads are the means by which the DVD/VCR reads the picture from the tape during playback. In the unlikely event that the heads become dirty enough to be clogged, no picture will be played back. This can easily be determined if, during playback of a known good tape, there is good sound, but no picture (picture is extremely snowy). If this is the case, have the DVD/VCR checked by qualified service personnel.



Good Picture



Snowy Picture

NOTES: • DO NOT ATTEMPT TO CLEAN THE VIDEO HEADS OR SERVICE THE UNIT BY REMOVING THE REAR COVER.

- Video heads may eventually wear out and should be replaced when they fail to produce clear pictures.
- To help prevent video head clogging, use only good quality VHS tapes. Discard worn out tapes.

Notes

Auto Clock Setting

Notes for Canadian customers regarding the clock feature of your DVD/VCR.

The XDS signals are carried only by certain broadcast television stations (for example, the signal is carried by most Public Broadcasting Service stations). You must be able to receive a station carrying the XDS signal to use the Auto Clock Setting to set your DVD/VCR's internal clock. If you live in an area that does not broadcast XDS signals, you must set the clock manually. Please see page 23 for instructions on how to manually set your DVD/VCR's clock.

Special note for residents of Newfoundland:

The Auto Clock Setting cannot be used to set the DVD/VCR's internal clock to Newfoundland time. The time zone command does not include a setting for the Newfoundland time zone. Trying to use the Auto Clock Setting in the Newfoundland time zone could result in an incorrect time setting or no setting at all. Please set your DVD/VCR's clock using the Manual Clock Setting.

GENERAL

Power supply:	AC 120V 60Hz
Power consumption:	Operation: 20W Stand by: 3W
Weight:	9.9lbs (4.5 kg)
Dimensions:	Width : 16-15/16 inches (430 mm) Height: 3-7/8 inches (99 mm) Depth : 12-1/4 inches (311 mm)
Inputs/Outputs:	
Video:	In: 1Vp-p/75 ohm Out: 1Vp-p/75 ohm
Audio:	In: -8 dBm/50K ohm Out: -8 dBm/1K ohm
Antenna:	UHF/VHF IN/OUT: 75 ohm coaxial
Hi-Fi Frequency Response:	20Hz to 20,000Hz
Hi-Fi Dynamic Range:	More than 90dB

VCR section

Video Head:	4 Rotary Heads
Audio Track:	Hi-Fi Sound - 2 Tracks / MONO Sound - 1 Track
Tuner:	181 Channel Freq. Synthesized VHF 2-13 UHF 14-69 CATV 14-36 (A)-(W) 37-59 (AA)-(WW) 60-85 (AAA)-(ZZZ) 86-94 (86)-(94) 95-99 (A-5)-(A-1) 100-125 (100)-(125) 01 (5A)
RF Channel Output:	Channel 3 or 4, Switchable
F.FWD/REW Time:	Approx. 1 minute 48 seconds (with T-120 Cassette Tape) (at+25°C)

DVD section

Signal system:	NTSC
Applicable disc:	DVD (12cm, 8cm), CD (12cm, 8cm)
Audio characteristics:	DVD: 4Hz - 22KHz
Frequency response:	CD: 4Hz - 20KHz
S/N Ratio:	90dB
Harmonic distortion:	0.02%
Wow and flutter:	Below Measurable Level
Dynamic range:	90dB
Output:	Video : (RCA) 1 Vp-p/75ohm Audio : (RCA) -8 dBm/1Kohm Digital Audio : 0.5Vp-p 75 ohm
Pickup:	CD : Wavelength: 775 - 805 nm Maximum output power: 0.5 mW DVD : Wavelength: 640 - 660 nm Maximum output power: 1.0 mW

ACCESSORIES:

Remote control x 1
Batteries (2 x AA)
75 ohm Coaxial Cable x 1
AUDIO/VIDEO Cable x 1

FOR SERVICING (Only in U.S.A.)

HOW TO LOCATE YOUR JVC SERVICE CENTER

TOLL FREE: 1-800-537-5722

<http://www.jvc.com>

Dear Customer,

In order to receive the most satisfaction from your purchase, please read the instruction booklet before operating the unit. In the event that repair is necessary, or for the address nearest your location within the Continental United States, please call 1-800-537-5722 for your nearest authorized servicer or visit our website at www.JVC.com. Remember to retain your Bill of Sale for Warranty Service.

— JVC

JVC SERVICE & ENGINEERING COMPANY OF AMERICA

DIVISION OF JVC AMERICAS CORP.

Sophisticated electronic products may require occasional service. Just as quality is a keyword in the engineering and production of the wide array of JVC products, service is the key to maintaining the high level performance for which JVC is world famous. The JVC service and engineering organization stands behind our products.

NATIONAL HEADQUARTERS
JVC SERVICE & ENGINEERING COMPANY OF AMERICA
DIVISION OF JVC AMERICAS CORP.
10 New Maple Avenue
Pine Brook, NJ 07058-9641

ACCESSORIES

*To purchase accessories for your JVC product, you may contact your local JVC Dealer.
From the 48 Continental United States call toll free:
1-800-882-2345 or on the web at www.JVC.com*

Don't service the product yourself.

CAUTION

*To prevent electrical shock, do not open the cabinet.
There are no user serviceable parts inside.
Please refer to qualified service personnel for repairs.*

WARRANTY (Only in U.S.A.)

LIMITED WARRANTY

CONSUMER VIDEO 1-90

JVC COMPANY OF AMERICA warrants this product and all parts thereof, except as set forth below ONLY TO THE ORIGINAL PURCHASER AT RETAIL to be FREE FROM DEFECTIVE MATERIALS AND WORKMANSHIP from the date of original retail purchase for the period as shown below. ("The Warranty Period")

PARTS	LABOR
1YR	90DAYS

THIS LIMITED WARRANTY IS VALID ONLY IN THE FIFTY (50) UNITED STATES, THE DISTRICT OF COLUMBIA AND IN COMMONWEALTH OF PUERTO RICO.

WHAT WE WILL DO:

If this product is found to be defective, JVC will repair or replace defective parts at no charge to the original owner. Such repair and replacement services shall be rendered by JVC during normal business hours at JVC authorized service centers. Parts used for replacement are warranted only for the remainder of the Warranty Period. All products and parts thereof may be brought to a JVC authorized service center on a carry-in basis except for Television sets having a screen size 25 inches and above which are covered on an in-home basis.

WHAT YOU MUST DO FOR WARRANTY SERVICE:

Return your product to a JVC authorized service center with a copy of your bill of sale. For your nearest JVC authorized service center, please call toll free: (800) 537-5722.

If service is not available locally, box the product carefully, preferably in the original carton, and ship, insured, with a copy of your bill of sale plus a letter of explanation of the problem to the nearest JVC Factory Service Center, the name and location of which will be given to you by the toll-free number.

If you have any questions concerning your JVC Product, please contact our Customer Relations Department.

WHAT IS NOT COVERED:

This limited warranty provided by JVC does not cover:

1. Products which have been subject to abuse, accident, alteration, modification, tampering, negligence, misuse, faulty installation, lack of reasonable care, or if repaired or serviced by anyone other than a service facility authorized by JVC to render such service, or if affixed to any attachment not provided with the products, or if the model or serial number has been altered, tampered with, defaced or removed;
2. Initial installation and installation and removal for repair;
3. Operational adjustments covered in the Owner's Manual, normal maintenance, video and audio head cleaning;
4. Damage that occurs in shipment, due to act of God, and cosmetic damage;
5. Signal reception problems and failures due to line power surge;
6. Video Pick-up Tubes/CCD Image Sensor, Cartridge, Stylus (Needle) are covered for 90 days from the date of purchase;
7. Accessories;
8. Batteries (except that Rechargeable Batteries are covered for 90 days from the date of purchase);

There are no other express warranties except as listed above.

THE DURATION OF ANY IMPLIED WARRANTIES INCLUDING THE IMPLIED WARRANTY OF MERCHANTABILITY, IS LIMITED TO THE DURATION OF THE EXPRESS WARRANTY HEREIN.

JVC SHALL NOT BE LIABLE FOR THE LOSS OF USE OF THE PRODUCT, INCONVENIENCE, LOSS OR ANY OTHER DAMAGES, WHETHER DIRECT, INCIDENTAL OR CONSEQUENTIAL (INCLUDING, WITHOUT LIMITATION, DAMAGE TO TAPES, RECORDS OR DISCS) RESULTING FROM THE USE OF THIS PRODUCT, OR ARISING OUT OF ANY BREACH OF THIS WARRANTY. ALL EXPRESS AND IMPLIED WARRANTIES, INCLUDING THE WARRANTIES OF MERCHANTABILITY AND FITNESS FOR PARTICULAR PURPOSE, ARE LIMITED TO THE WARRANTY PERIOD SET FORTH ABOVE.

Some states do not allow the exclusion of incidental or consequential damages or limitations on how long an implied warranty lasts, so these limitations or exclusions may not apply to you. This warranty gives you specific legal rights and you may also have other rights which vary from state to state.

JVC COMPANY OF AMERICA
DIVISION OF JVC AMERICAS CORP.

1700 Valley Road
Wayne, New Jersey 07470

REFURBISHED PRODUCTS CARRY A SEPARATE WARRANTY, THIS WARRANTY DOES NOT APPLY. FOR DETAILS OF REFURBISHED PRODUCT WARRANTY, PLEASE REFER TO THE REFURBISHED PRODUCT WARRANTY INFORMATION PACKAGED WITH EACH REFURBISHED PRODUCT.

For customer use:

Enter below the Model No. and Serial No. which is located either on the rear, bottom or side of the cabinet. Retain this information for future reference.

Model No.: _____

Serial No.: _____

Purchase date: _____

Name of dealer: _____

